7100A ADVANCED CONTROLLERS

**SINGLE-PHASE
POWER THYRISTOR UNITS**

7000 RANGES

**User
Manual**

© Copyright Eurotherm Limited 2002

All rights reserved. All reproduction or transmission in any form whatsoever and using any procedure (electronic or mechanical, including photocopying and recording) without written permission from Eurotherm is strictly prohibited.

CONTENTS

	Page
European directives and applicable standards	iii
Commissioning flowchart	iv
Chapter 1 Identification of power thyristor units	1-1
Chapter 2 Installation	2-1
Chapter 3 Firing modes	3-1
Chapter 4 Control and limits	4-1
Chapter 5 Alarms	5-1
Chapter 6 Maintenance	6-1
Eurotherm	7-1

PURPOSE OF MANUAL

This is the **Issue 2.0 User Manual**.

It describes the Basic Version and all options for 7100A series power thyristor units with current ratings from 16 A to 250 A.

EUROPEAN DIRECTIVES AND APPLICABLE STANDARDS

COMPLIANCE WITH PRODUCT STANDARD

7100A products comply with the terms of product standard **EN 60947-4-3** 'Contactors and motor-starters - AC semiconductor controllers and contactors for non-motor loads'.

CE LABELLING

7100A products installed and used in accordance with the user manual, bear CE labelling on the basis of compliance with the essential requirements of the **European Low Voltage Directive** 73/23 EEC dated 19 February 1973, modified by 93/68/EEC dated 22 July 1993 and the **Electromagnetic Compatibility Directive** 89/336/EEC dated 3 May 1989 modified by 92/31/EEC dated 28 April 1992 and 93/68/EEC dated 22/07/93.

SAFETY

The units have IP20 protection rating as defined by standard IEC 60529. External wiring must comply with standards IEC 60364-4-43 and IEC 60943. Copper cables and conductors must be used, rated to a temperature of 75°C (167°F).

ELECTROMAGNETIC COMPATIBILITY (EMC)

7100A products installed and used in accordance with the user manual, are designed for an industrial environment and must not be used in the home.

EMC TEST STANDARDS

The units comply with the following EMC test standards, in accordance with the 'AC semiconductor motor controllers and conductors for non-motor loads' standard EN 60947-4-3:

Immunity: EN 61000-4-2, EN 61000-4-3, EN 61000-4-4, EN 61000-4-5, EN 61000-4-6, EN 61000-4-11

Radiated emissions: CISPR 11 (mod 1990)
Conducted emissions: CISPR 11 (mod 1990) Class A, Group 2
(near zero voltage switching)

EMC FILTER (conducted emissions)

For facilities required to comply with the levels stipulated under the generic standard for conducted emissions, EN 50081-2, Eurotherm can provide optional filters on units up to 100 A: - external filters for thyristor firing angle variation units

EMC GUIDE

To help you deal with installation-dependent electromagnetic interference effects, Eurotherm provides an 'Electromagnetic compatibility' installation guide (ref. HA 025464) which sets out best current practice regarding EMC.

DECLARATION OF COMPLIANCE

An EC declaration of compliance is available on request.

COMMISSIONING FLOWCHART

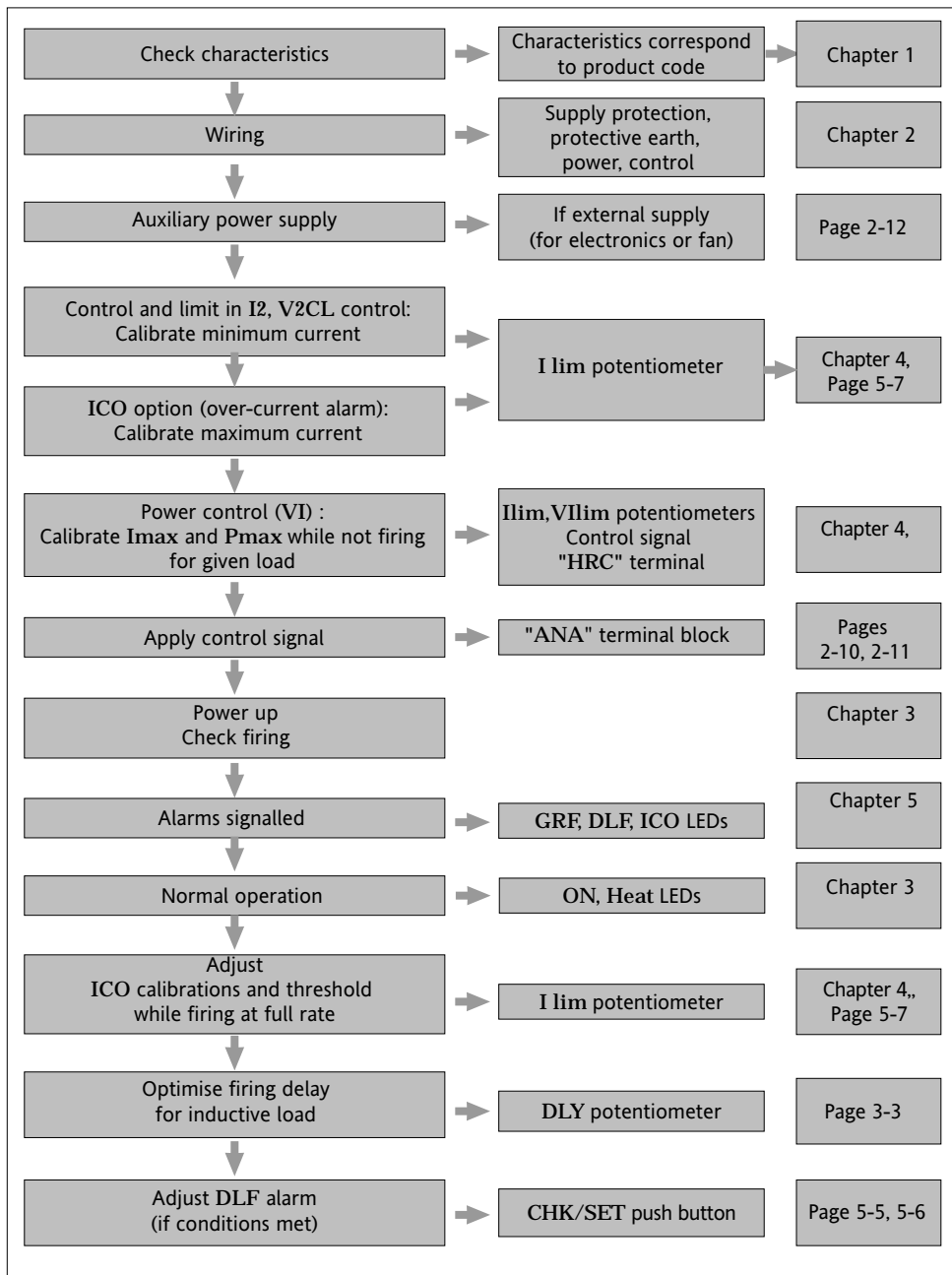

Chapter 1

IDENTIFICATION OF POWER THYRISTOR UNITS

Contents	Page
1.1. General presentation	1-2
1.2. Technical specifications	1-7
1.2.1. Power	1-7
1.2.2. Load	1-7
1.2.3. Dimensions	1-7
1.2.4. Control	1-8
1.2.5. Firing Modes	1-8
1.2.6. Control	1-8
1.2.7. Signalling	1-
1.2.8. Alarms	1-9
1.2.8.1. Load Monitorin Alarms	1-9
1.2.8.2. OverLoad Alarms	1-9
1.2.8.3. Alarm Relay	1-9
1.2.9. Protection	1-10
1.2.10. Mounting	1-10
1.2.11. Environment	1-10
1.3. Coding	1-11

Chapter 1 IDENTIFICATION

1.1. GENERAL PRESENTATION

7100A series power thyristor units are used to control the electrical power of single phase industrial loads of all types. The load controlled may be : high or low temperature coefficient resistive loads, short wave infrared elements or transformer primaries.

Current ratings vary from **16 A** to **250 A** (see coding), at voltages of **100 V** to **500 V**.

7100A series power thyristor units (rating up to 100 A) comprise two channels, one controlled by thyristors, and one direct internal channel.

7100A units **above 125 A** only comprise a single controlled channel.

Lite version :

- Units without options
- One Alarm option (GRF or DLF) **or** one Control option (V2CL or I2)
These configurations can be combined depending on the case, with the open loop code (OL) or the transformer primary code (XFMR).
- The Power Control option (VICL) is not available on the lite version

Full version :

- Power Control option (VICL) only or combined with other options
- Alarm option (GRF or DLF) combined with Control option (V2CL,I2 or VICL)
- Overload option ICO

1.1.1. 7100A unit from 16A to 40A 'lite' version

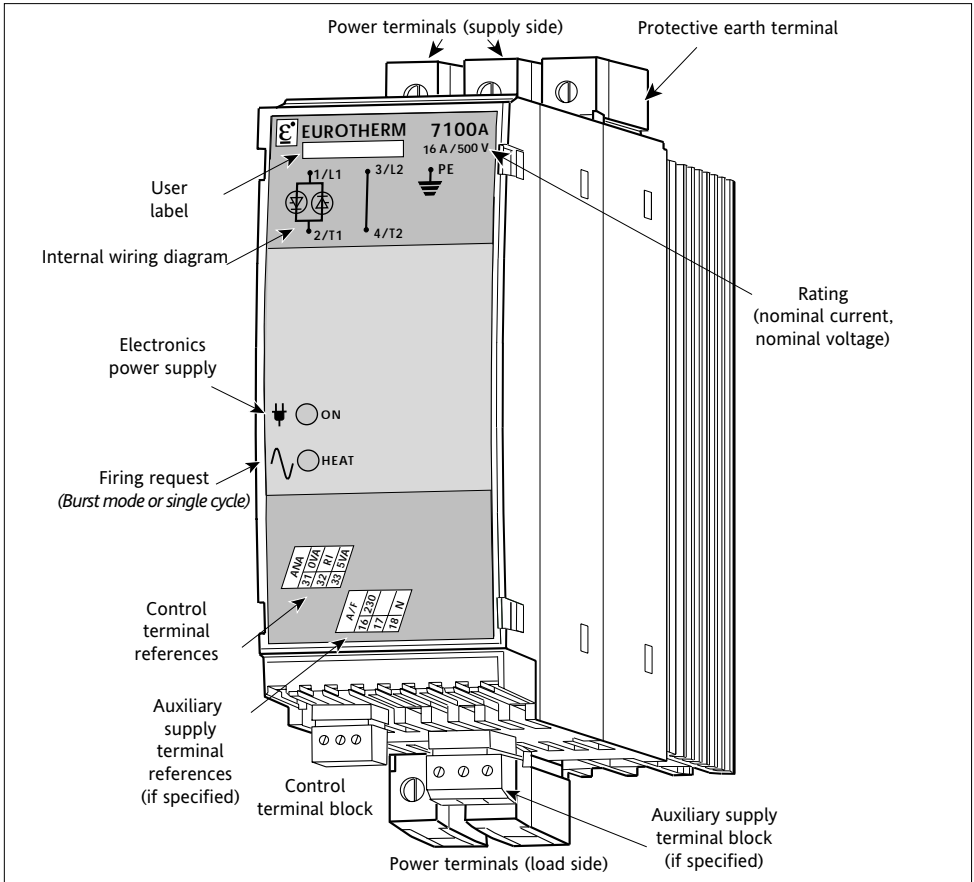

Figure 1-1 General view of 7100A power thyristor unit 16A to 40A 'lite' version

1.1.2. 7100A units from 16A to 63A 'full' version and 63 A 'lite'

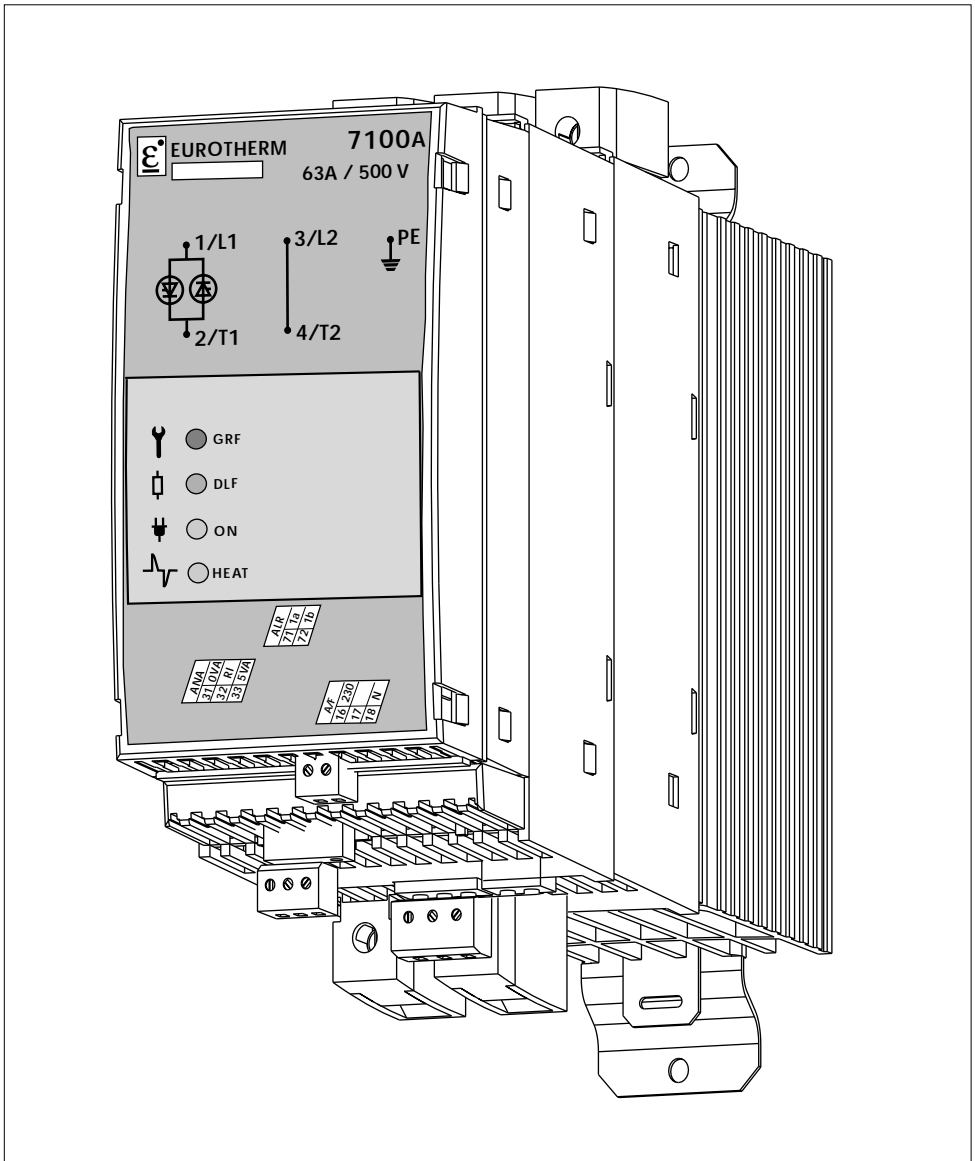

Figure 1-2 General view of 7100A power thyristor unit 16A to 63A 'full' version and 63 'lite'

1.1.3. 7100A units from 80A to 100A ‘lite’ and ‘full’ version

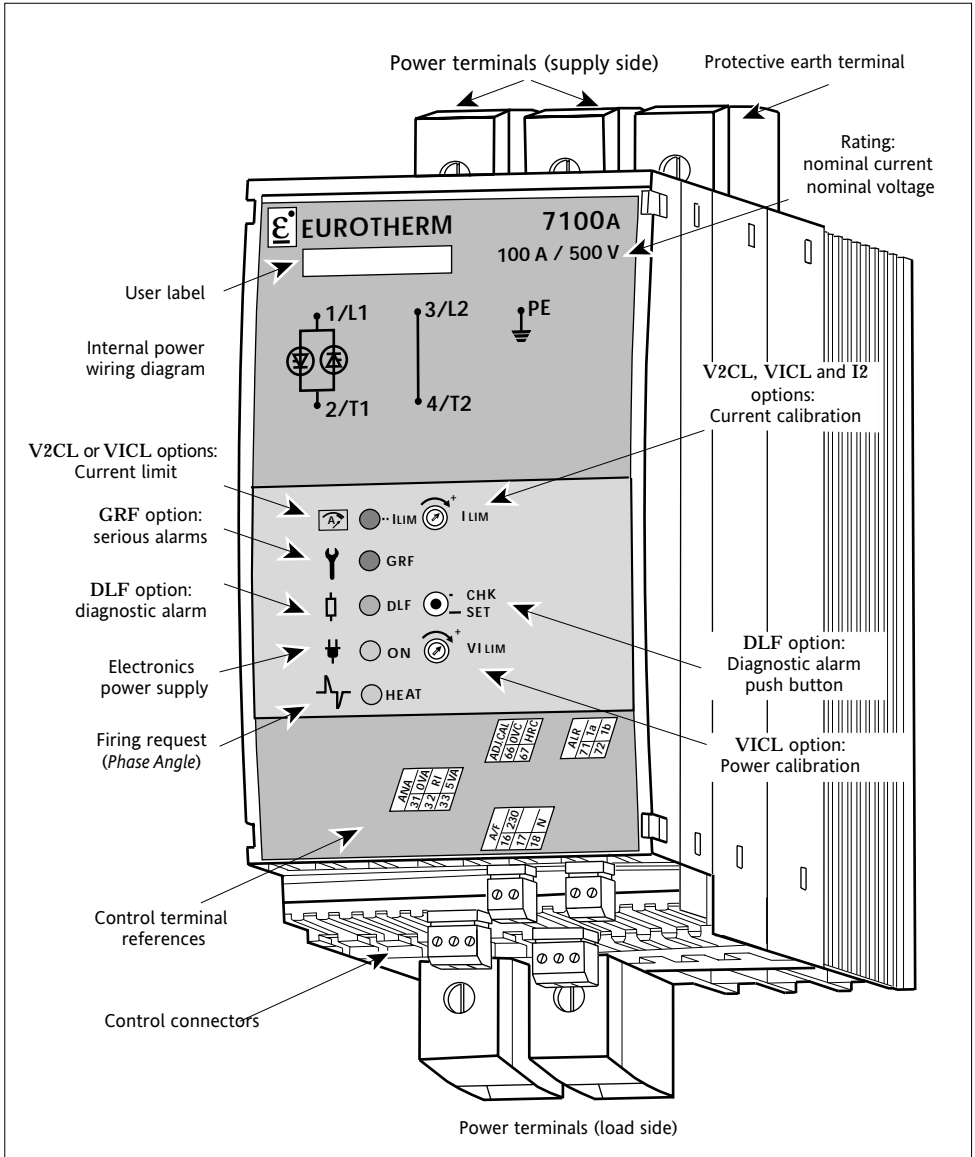

Figure 1-3 General view of 7100A power thyristor unit 80A to 100A ‘lite’ and ‘full’ version

1.1.4. 7100A units from 125A to 250A 'lite' version only

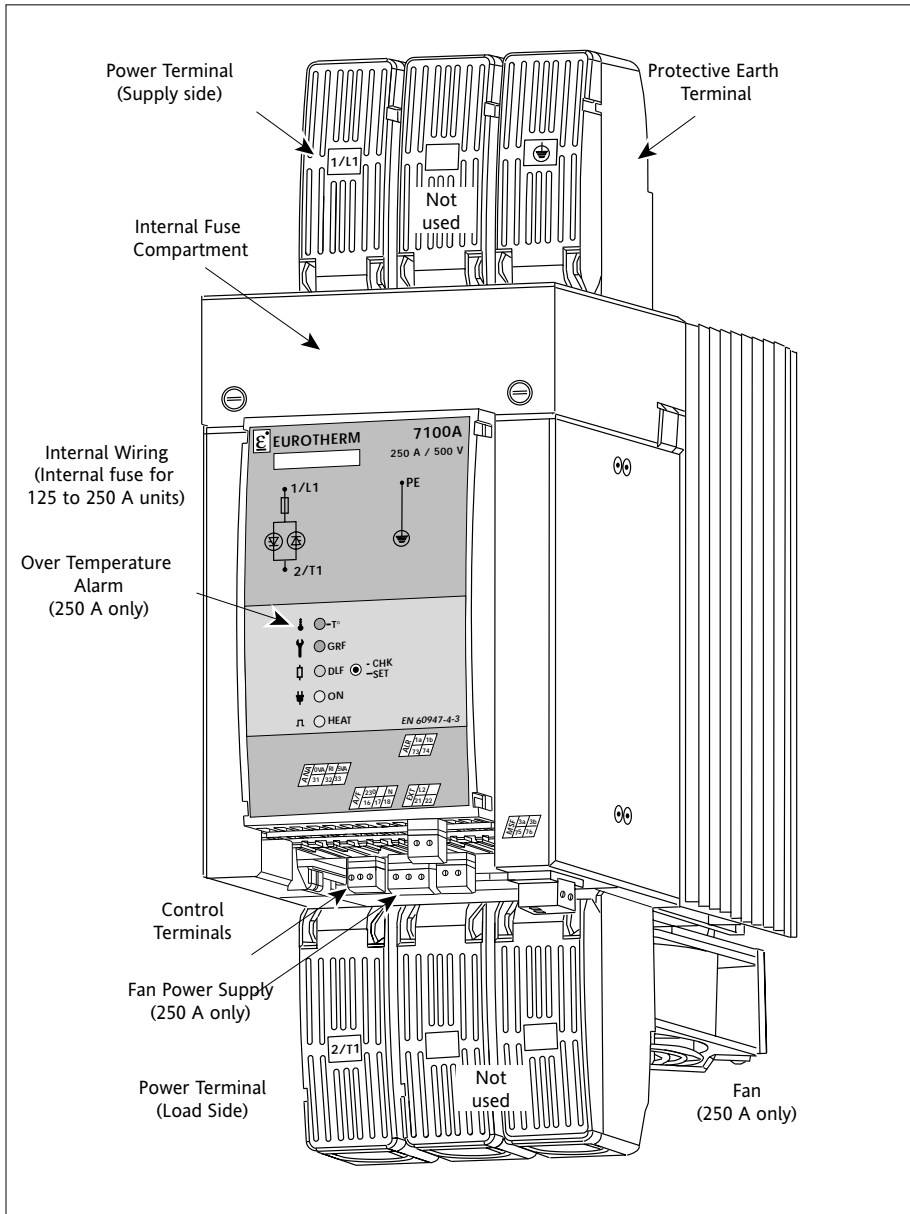

Figure 1-4 General view of 7100A power thyristor unit 125A to 250A 'lite' version only

1.2. TECHNICAL SPECIFICATIONS

1.2.1. Power

Nominal current	16A to 250A at 45°C (see product code)
Nominal voltage	100 V to 500 V (see code).
Frequency	Use from 47 to 63 Hz
Dissipated power	1.3 W (approx.) per amp.
Cooling	Ratings ≤ 100 A: Natural convection Ratings ≥ 125 A: 115 V or 230 V fan, consumption 10 VA

1.2.2. Load

Categories of use	<p>Single-phase industrial load: The categories of use applicable for each unit are indicated on the identification label</p> <ul style="list-style-type: none"> AC-51 Non-inductive or low inductance loads, furnace resistances (Resistive load with low temperature coefficient). AC-55b Switching of incandescent lamps (Short wave infrared elements, SWIR units ≤ 100 A only). AC-56a Switching of transformers (Transformer primaries and high temperature coefficient resistive loads).
-------------------	--

1.2.3. Dimensions

Rating (A)	Height (mm)	Length (mm)		Depth (mm)		
		Lite	Full	Lite		Full
				Base (1)	Option (2)	
16 to 40	156	52,5	70	193	218	237
63	156	70	70	212	237	237
80 to 100	226	96	96	215	243	243
125 to 250	423	144	N/A	372	372	N/A

Note (1) : Basic product, without alarm option or control (except V2 and OL)

Note (2) : Product with one control option (I2 or V2CL) or one alarm option (GRF or DLF)

1.2.4. Control

Supply

Self-powered from line or external power supply (115 V or 230 V +10%; -15%).
Consumption: 10 VA.

Control type

Analogue (digital communication with option)

- either remote analogue setpoint
0-5 V or 0-10 V (100 k Ω input),
0-20 mA or 4-20 mA (250 Ω input)
- or manual setpoint (potentiometer);
5 V supply available for use with 10 k Ω potentiometer.

1.2.5. Firing modes

Zero crossing firing

- Burst mode, base time 16 or 64 cycles
- Single-cycle, 1 base cycle
- Advanced single-cycle, 1 base cycle
(firing by *whole cycles*,
non-firing by *half cycles*).
- Phase angle

Firing angle variation

1.2.6. Control

Control parameter

- Standard:
Load voltage squared (V^2)
- Option:
 - Apparent power ($V \cdot I$, VICL option) up to 100 A only
 - Load current squared (I^2 option) in Phase angle
 - Open loop in Phase angle.

Linearity and Stability

Better than $\pm 2\%$ of full scale.

Current limit

Option, depending on firing mode:

(V^2 CL option)

- Phase angle:
 - Automatic control transfer
($V^2 \leftrightarrow I^2$ or $V \cdot I \leftrightarrow I^2$)
 - Current recalibration
set by potentiometer on front panel.

- Burst mode, 16 cycle base:
Current limit with fixed threshold,
set by potentiometer on front panel.

Calibration

A control signal is available in $V \cdot I$ control for power and current calibration and for maintenance.

Transient current limit

Option to control transformer primaries

(XFMR option)

- in Burst mode:
 - Transformer magnetisation firing angle ramp on first firing and after firing is stopped for 5 seconds or more.
 - Delay on first firing set by potentiometer on front panel.

For all loads in Phase Angle firing:
Safety ramp with each change of setpoint.

1.2.7. Signalling

Electronics supply present:

green 'ON' LED.

Thyristor firing request:

green 'HEAT' LED.

1.2.8. ALARMS (Options)

1.2.8.1. Load Monitoring alarms (Options)

• Serious alarms (GRF option)	Total load failure and thyristor short circuit detection
Signalling	Red 'GRF' LED and alarm relay contact
• Diagnostic alarm (DLF option)	Partial load failure detection.
Signalling	Orange 'GRF' LED and alarm relay contact.
Settings	Monitoring diagnosis, alarm adjustment and resetting using push button on front panel.
Sensitivity	Detects the failure of at least one heating element for six identical elements connected in parallel.
Extension	The DLF option includes the GRF serious alarm monitoring.
• Over-temperature alarm	For all fan-cooled units (≥ 125 A), the unit cuts out if the temperature threshold is exceeded.
Signalling	Red 'T°' LED if one of the <i>I2</i> , <i>VI</i> or <i>CL</i> alarms or regulation options is selected. Alarm relay contact with any one alarm.

1.2.8.2. Overload alarms (Option)

• Overload alarm (ICO Option)	Cut-out if current threshold exceeded Only available for <i>Zero crossing firing</i> with DLF option (not available with <i>Short wave infrared</i> elements, <i>transformers</i> and codes <i>VICL</i> and <i>V2CL</i>)
	<u>Two alarm thresholds:</u> instantaneous current and rms current.
	Simultaneous current threshold adjustable from 20 to 100% using potentiometer on front panel.
Signalling	Red 'ICO' LED and alarm relay contact. Acknowledged by logic input.

1.2.8.3. Alarm relay

Available with one of the Alarm options.
The relay contact (0.25 A/230 Vac; 32 Vdc) is either open on alarm or closed on alarm depending on the product code.

1.2.9. Protection

Electrical protection
Thyristors

IP20 without adding additional protection.

Varistor and RC snubber

High speed fuse:

- rating ≤ 100 A: external (see code)
- rating ≥ 125 A: internal.

No fuse for Short wave infrared elements
in Burst mode and Single-cycle firing, or
Phase angle without Current limit.

1.2.10. Mounting

Mounting type

Attachment plate fixed to unit:

- on symmetrical EN50022 DIN rail or
- bulkhead mounting

(for ratings ≥ 125 A: bulkhead mounting only)

1.2.11. Environment

Use

0 to 45 °C at nominal current, max altitude 2000 m

Storage

Pollution

-10°C to 70°C.

Humidity

Degree 2 acceptable (defined by IEC 664).

Over-voltage

RH 5% to 95%, non-condensing, non-streaming.

Over-voltage category II (as defined by IEC 664).

1.3. CODING

Identification

	Ratings	Basic selection
7100A CODING: 1 / 2 / 3 / 4 / 5 / 6 / 7 / 8 / 9 / 10 /		

Ratings

1. Nominal current	Code
16 amps	16A
25 amps	25A
40 amps	40A
63 amps	63A
80 amps	80A
100 amps	100A
125 amps	125A
160 amps	160A
200 amps	200A
250 amps	250A

2. Nominal voltage	Code
100 volts	100V
115 volts	115V
120 volts	120V
127 volts	127V
200 volts	200V
208 volts	208V
220 volts	220V
230 volts	230V
240 volts	240V
277 volts	277V
400 volts	400V
460 volts	460V
480 volts	480V
500 volts	500V

3. Power supply for electronics	Code
Self-powered (standard)	SELF
External 115 V supply	115V
External 230 V supply	230V

4. Fan power supply	Code
≤ 200A: No fan	XXXX
≥ 250A:	
- 115 V fan and 115 V	115V
- 230 V fan and 230 V	230V

5. Thyristor fuse	Code
Fuse without fuse blown microswitch	FUSE
Fuse with fuse blown microswitch	MSFU
No fuse	NONE

Basic selection

6. Firing mode	Code
<i>Phase angle</i>	PA
Advanced single-cycle: 1 base cycle non-firing by half cycles	ASC
Burst mode:	
Single-cycle: 1 base cycle	FC1
base time 16 cycles	C16
base time 64 cycles	C64

7.	XXXX
----	-------------

8. Input	Code
Analogue signal:	
current from 0 mA to 20 mA	0mA20
current from 4 mA to 20 mA	4mA20
voltage from 0 V to 5 V	0V5
voltage from 0 V to 10 V	0V10

9. Manual language	Code
French	FRA
English	ENG
German	GER

10. Selected options	Code
Base version: No options, Standard V ² control End of code	NONE
Version with options: Selection of options	YES

Options

11 / 12 / 13 / 14 / 15 / 16 / 17 / 18 / 19

Options

11. Control options	Code
Voltage control (V ²)	V2
<i>PA only:</i> Current control (I ²)	I2
Open loop	OL
<i>C16 and PA only:</i> Voltage control (V ²) and Current limit	V2CL
Power control (V x I) and Current limit	VICL

12. Delay on first firing	Code
<i>Burst firing C16 or C64:</i> Transformer primary Other configurations	XFMR XXXX

13. Load Monitoring alarms	Code
Serious Alarms: Thyristor short-circuit, Total Load failure, over-temperature for rating 250 A	GRF
Partial load failure and Serious alarms	DLF
No alarms	NONE

14. Load type	Code
<i>With DLF option:</i> Short wave infrared Low temperature coefficient load	SWIR LTCL
<i>Without DLF option or</i> High temperature coefficient load	XXXX

15. OverLoad alarm (with DLF option and burst firing only)	Code
Overload alarm <i>except</i> codes SWIR, XFMR, VICL and V2CL	ICO
No over-current alarm	XXXX

16. Alarm relay contact	Code
<i>With alarm option:</i> Contact closed on alarm	NC
Contact open on alarm	NO
<i>Without alarm option</i>	XX

Certification Options and Warranty extension

17.	XXXX
-----	------

18.	XXXX
-----	------

19. Certification option	Code
No certificate of 'Compliance with Order'	NONE
Certificate of 'Compliance with Order'	CFMC

20. Warranty extension	Code
Without warranty extension	NONE
Warranty extended to 5 years	WL005

Chapter 2

INSTALLATION

Contents	Page
2.1. Safety during installation	2-2
2.2. Types of mounting	2-3
2.2.1. Attachment plate	2-3
2.2.2. Mounting / Detaching on DIN rails	2-3
2.2.3. 16 A to 63 A units mounting	2-4
2.2.3.1. DIN rails mounting	2-4
2.2.3.2. Bulkhead mounting	2-4
2.2.4. 80 A to 100 A units mounting	2-5
2.2.4.1. DIN rails mounting	2-5
2.2.4.2. Bulkhead mounting	2-5
2.2.5. 125 A to 250 A units mounting	2-6
2.3. Wiring	2-7
2.3.1. Power connections	2-7
2.3.1.1. 7100 A units from 16 A to 100 A wiring diagram	2-8
2.3.1.2. 7100 A units from 125 A to 250 A wiring diagram	2-9
2.3.2. Control connections	2-10
2.3.2.1. Control terminal block	2-10
2.3.2.2. Control signal	2-11
2.3.2.3. Power supply for electronics	2-12
2.3.2.4. Alarm relay contact	2-12
2.3.2.5. Acknowledgement signal	2-12

Chapter 2 installation

2.1. SAFETY DURING INSTALLATION (MOUNTING AND WIRING)

Danger!



- 7100A power thyristor units must be installed and wired by qualified staff authorised to work on low voltage industrial electrical facilities.

- Units must be installed in a fan-cooled cabinet, to ensure that condensation and pollution are excluded, with a class of at least 2 according to IEC 664.

We recommend fitting fan-cooled cabinets with a fan failure detection device or a thermal safety cut-out.

The cabinet must be closed and connected to the protective earth according to IEC 60364 or applicable national standards.

- Units must be mounted with the heatsink positioned vertically, and with no obstructions above or below the unit which could reduce or hamper air flow. If several units are fitted in the same cabinet, arrange them such that air from one unit is not drawn in by the unit above.

Leave a gap of at least 10 mm between adjacent units.

Important!



- Nominal currents correspond to use at ambient temperatures of no more than 45°C. Overheating may cause incorrect operation and may even lead to components being damaged.

Danger!



- It is the user's responsibility to wire and protect the facility according to best practice and applicable standards.

A suitable device, ensuring that the unit can be electrically isolated from the supply, must be installed upline to enable work to be performed safely.

Conductor cross-sections should comply with IEC 60943.

Only use copper cables and wires rated for use at 75°C.

- Before connecting or disconnecting the unit check that power and control cables and leads are isolated from voltage sources.

The protective earth must be connected before any other connections are made and should be the last cable to be disconnected.

The protective earth connection terminal is marked with the symbol



Important!



- To ensure that 7100A power thyristor units comply with Electromagnetic Compatibility requirements, ensure that the panel or DIN rail to which they are attached is correctly grounded.

The ground connection, designed to ensure **ground continuity**, is not in any way a substitute for the protective earth connection.

2.2. TYPES OF MOUNTING

Two types of mounting are possible:

- DIN rail mounting or
- bulkhead mounting with screws.

Current rating	DIN rail mounting		Bulkhead mounting	
	Attachment plate	DIN rail	Attachment plate	Screws
16 A to 63 A	One vertical plate	One EN50022 symmetric rail	One vertical plate	2 x M4
80 A and 100 A	Two horizontal plates	Two EN50022 symmetric rail	Two horizontal plates	4 x M4
≥ 125 A	Not applicable		Two horizontal plates	4 x M6

Table 2-1 Attachment details for both mounting types

2.2.1. ATTACHMENT PLATE

The **attachment plate**, shipped fitted to the rear of the 7100A power thyristor unit, is used:

- to clip the unit to a DIN rail, or
- to screw the unit to a bulkhead.

The attachment plate has:

- attachment holes for bulkhead mounting, and
- two fixed hooks and two mobile hooks for clipping to a DIN rail. (the mobile hooks are moved using a catch and spring).

2.2.2. MOUNTING / DETACHING UNITS IN DIN RAILS

- fix one symmetric DIN rail (rating 16 A to 63 A) or two rails (rating 80 A and 100 A), in accordance with the unit dimensions and safety recommendations.
- bring the unit up against the rail, engaging the two fixed hooks
- push the unit against the rail
- clip the unit onto the rail using the mobile hooks, ensuring that they are properly engaged.

To **detach** the unit:

- move the mobile hooks downwards by pulling on the catch
- unclip the unit from the rail.

2.2.3. 16A TO 63A UNITS MOUNTING

2.2.3.1. DIN RAIL MOUNTING

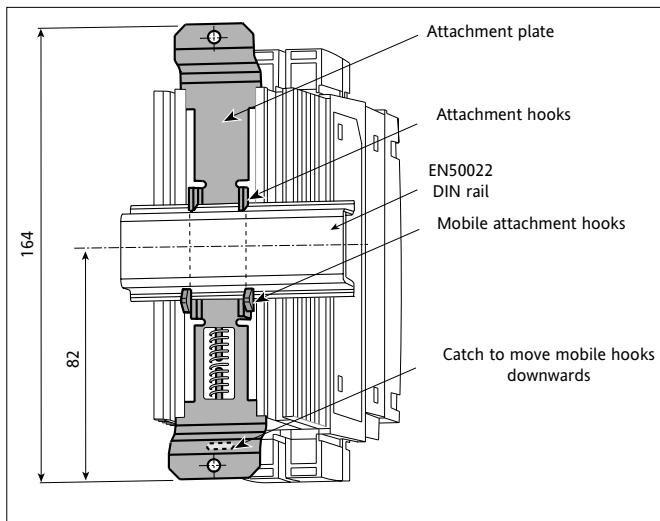

Figure 2-1 Attaching the 7100A power thyristor unit to a DIN rail (16A to 63A, rear view)

2.2.3.2. BULKHEAD MOUNTING

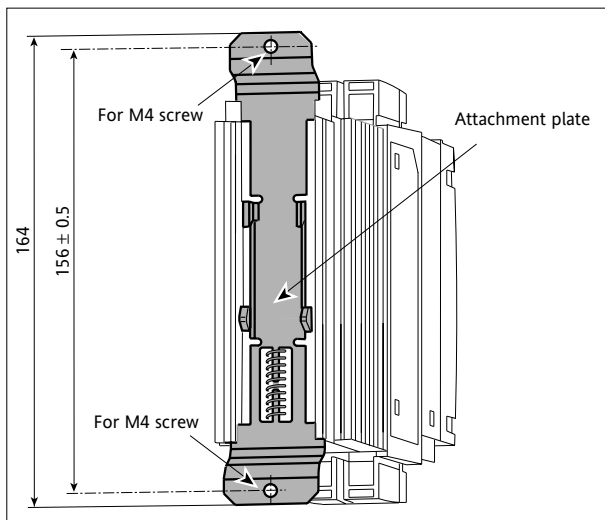

Figure 2-2 Bulkhead mounting using an attachment plate (16A to 63A, rear view)

2.2.4. 80A TO 100A UNITS MOUNTING

2.2.4.1. DIN RAIL MOUNTING

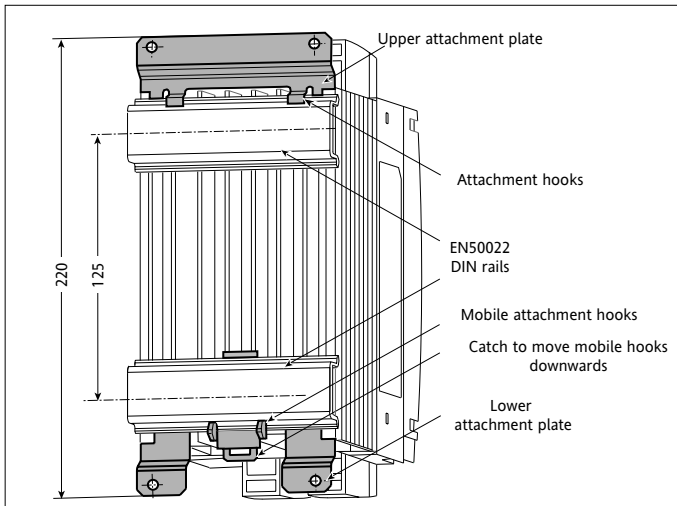

Figure 2-3 Attaching the 7100A power thyristor unit to DIN rails (80A and 100A, rear view).

2.2.4.2. BULKHEAD MOUNTING

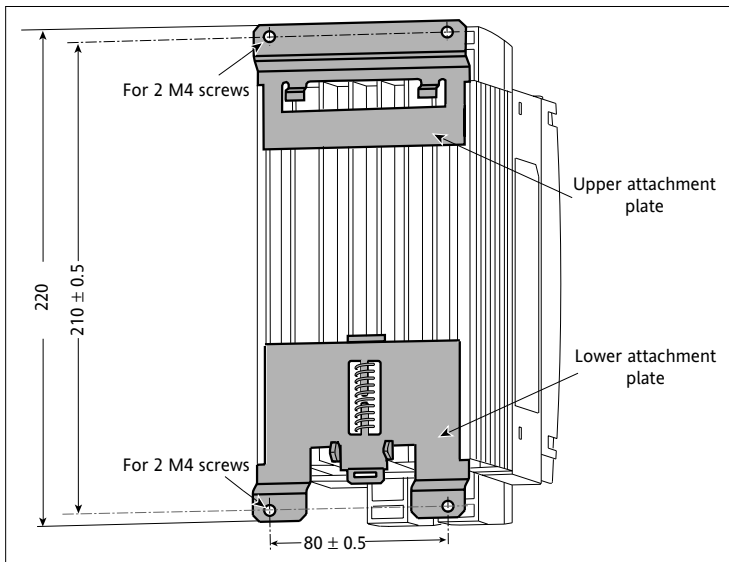

Figure 2-4 Bulkhead mounting using an attachment plate (80A and 100A, rear view).

2.2.5. 125A TO 250A UNITS MOUNTING

BULKHEAD MOUNTING

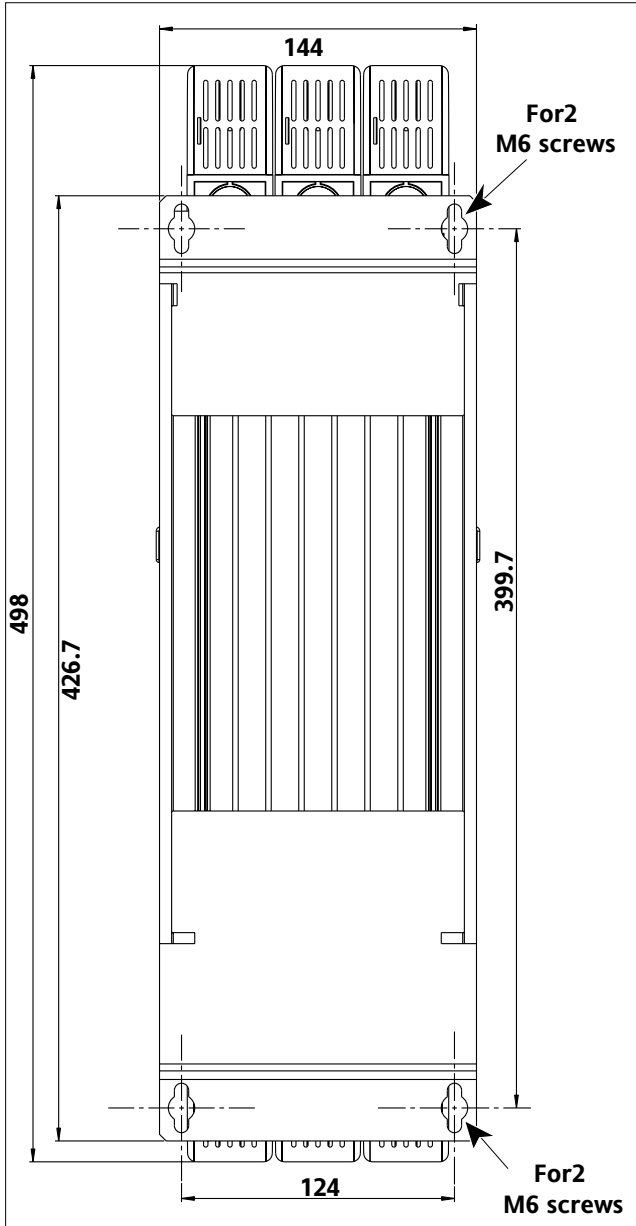

Figure 2-5 125A to 250A 7100 A unit mounting

2.3. WIRING

2.3.1. POWER CONNECTIONS

7100A power thyristor units with current ratings up to 100 A are fitted with:

- one channel controlled by thyristors
- an internal busbar for directly connecting the load to the power supply (direct channel, not controlled by thyristors).

The wiring diagram for this range of standard current ratings is shown in figure 2-6.

The protective earth terminal **PE** (marked with the earth symbol) must be wired to the protective earth (see section 'Safety during installation').

The 7100A units ≥ 100 A, are equipped of :

- One thyristor controlled channel and

The protective earth terminal **PE** (marked with the earth symbol) must be wired to the protective earth (see section 'Safety during installation').

Rating A	Terminal capacity		Torque Nm	Stripping length mm
	mm ²	AWG		
16 to 25	2.5 to 6	13 to 9	1.2	13
40 to 63	6 to 16	9 to 5	1.8	13
80 to 100	16 to 35	5 to 2	3.8	20

Table 2-2a Power connection details for ratings from 16 A to 100 A

Rating A	Terminal capacity		Torque Nm	Stripping length mm
	mm ²	AWG		
125	50 to 120	0	16,4 (or 28,8)	ø 10 (or ø 12)
160	70 to 120	00	M10 nut	
200	95 to 120	000	to attach eyelet	
250	120	-	and terminal	

Table 2-2b Power connection details for ratings from 125A to 250A

Conductor cross-sections should comply with IEC 60943.

2.3.1.1. 7100A units from 16A to 100A wiring diagram

The power connection to 7100A units is between one phase and neutral or between two phases depending on the nominal voltage for the thyristor unit.

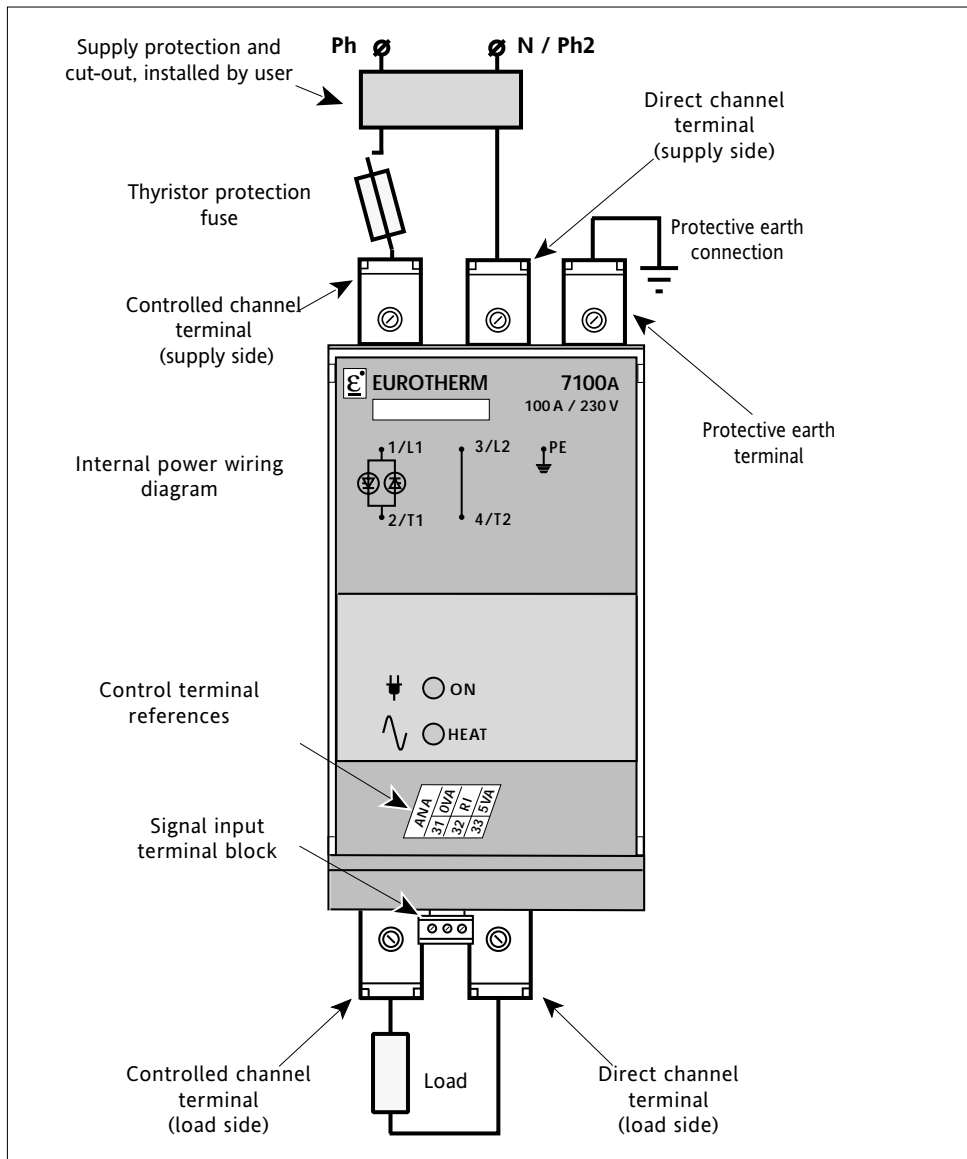

Figure 2-6 7100A power thyristor unit power and input signal connections (rating ≤ 100 A, no options, self-powered electronics)

2.3.1.2. 7100A units from 125A to 250A wiring diagram

The power connection to 7100A units is between one phase and neutral or between two phases depending on the nominal voltage for the thyristor unit.

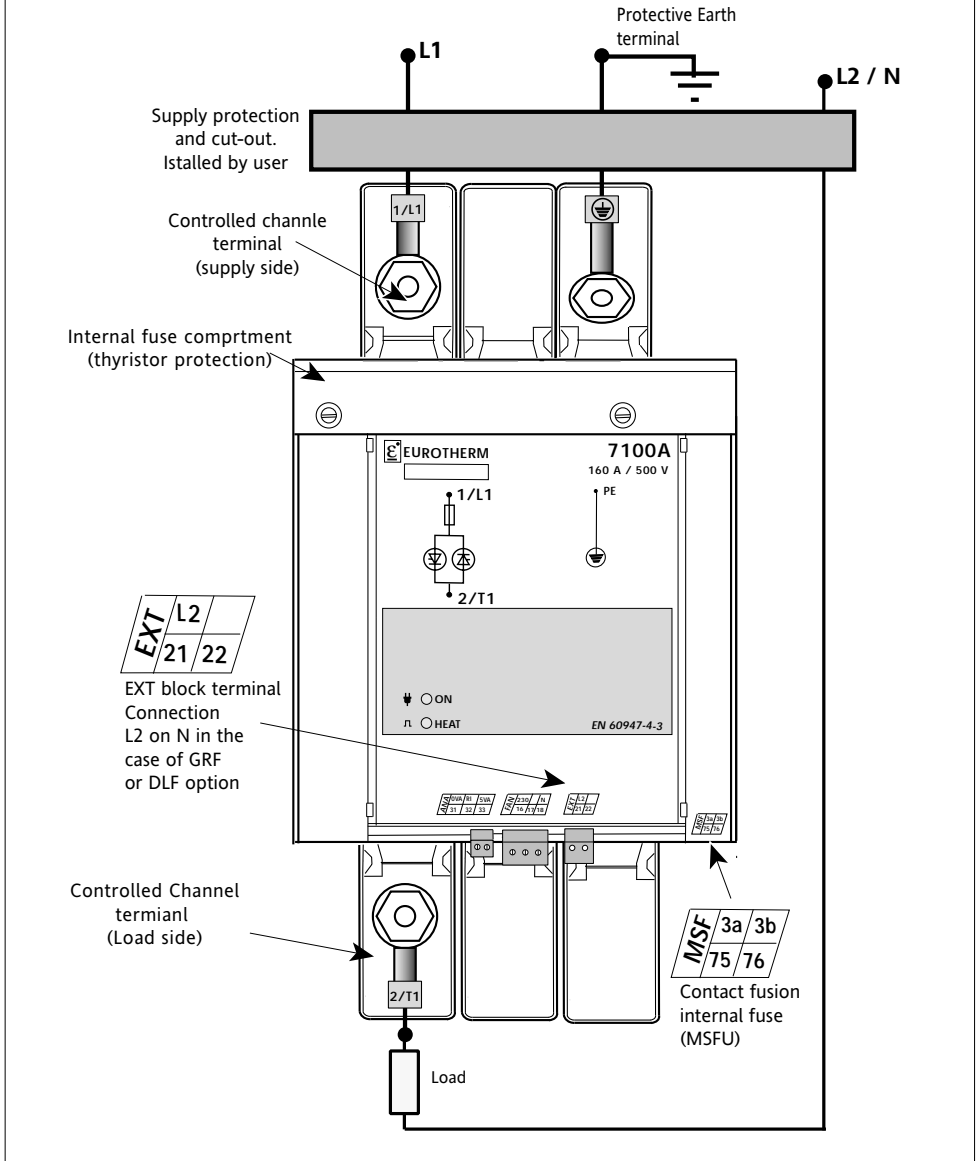

Figure 2-7 7100A power thyristor unit power and input signal connections (rating ≥ 100 A, self-powered electronics)

2.3.2. CONTROL CONNECTIONS

Terminal blocks on the underside of the 7100A power thyristor unit are used to connect:

- the control signals (analogue and logic)
- the auxiliary or electronics supply
- alarm relay and acknowledgement contacts

Examples of connecting the input signals, external electronics supply and alarm and acknowledgement contacts are shown below.

The wires used should be stripped for a length of 6 to 7 mm.

2.3.2.1. Control terminal blocks

The control terminal blocks are plug-in screw connectors.

The terminal blocks available depend on the power thyristor unit version and the selected options in the product code.

The terminals and numbers are marked on the front panel for available terminal blocks.

The table below gives details of all terminals and terminal blocks.

Terminal block name	Terminal description			Version	Terminal capacity		Torque Nm
	No.	Name	Purpose		mm ²	AWG	
ANA	31	0VA	0 V for analogue signals	Base or Options	1,5	16	0,5
	32	RI	'+' for analogue signals				
	33	5VA	Internal analogue 5 V supply				
A/F (except SELF)	16	230	230 V aux. supply	ICO option	2,5	14	0,7
	17	115	115 V aux. supply				
	18	N	Neutral or second phase				
DIG.IN	61	0VD	0 V logic signal	ICO option	1,5	16	0,5
	62	ACK	Acknowledgement				
	63	5VD	5 V internal logic				
ALR	71	1a	Alarm relay	Alarm Options	2,5	14	0,7
	72	1b	contact NC contact				
ALR	73	1a	Alarm relay	Alarm Options	2,5	14	0,7
	74	1b	contact NO contact				
ADJ.CAL	66	0VC	0 V calibration	V x I Control	1,5	16	0,5
	67	HRC	Calibration control				
MSF	75	3a	Relay contact	Microcontact ≥ 125 A	2,5	14	0,7
	76	3b					
EXT	21	L2	Neutral or 2nd phase	Alarm Options ≥ 125 A	2,4	14	0,7
	22	N/A	in the case of GRF ou DLF option				

Table 2-3 Description of control terminal blocks

2.3.2.2. Control signal

The analogue control signal terminal block is labelled ANA.

The input available corresponds to the input type selected in the product code (voltage or current and level of values). The signal must be connected between terminals 32 and 31.

A typical external signal connection is shown on figure 2-8a.

Figure 2-8b shows how to use the internal 5 V voltage (terminal 33 labelled 5VA) for manual control with an external 10 k Ω potentiometer.

Important!



The control signal input is polarised.

The '+' of the control signal must be connected to terminal 32 (labelled RI).

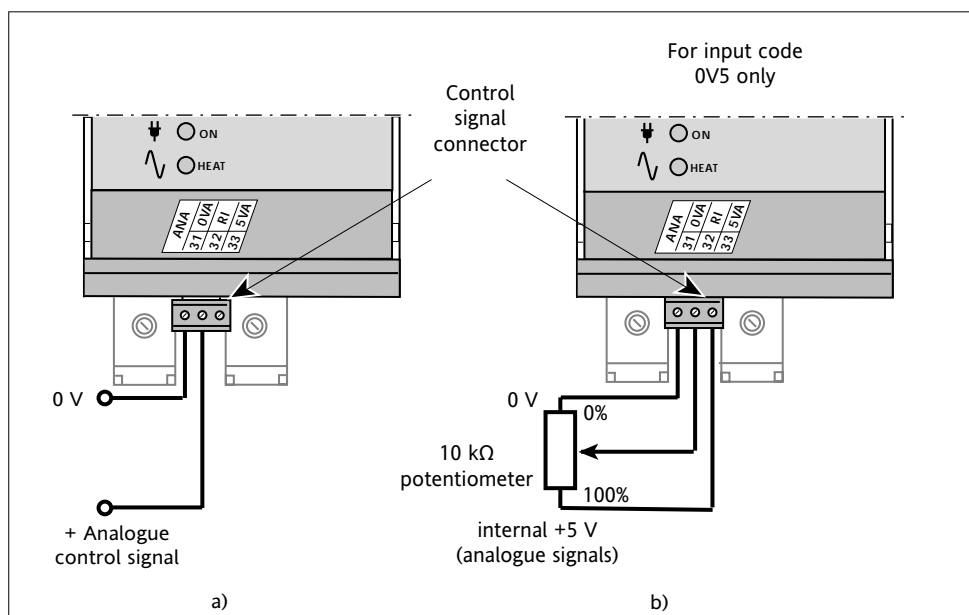

Figure 2-8 Control signal connection (self-powered unit without alarms)

- external signal, e.g. from Eurotherm series 2000 controller
- manual command from external potentiometer .

2.3.2.3. Power supply for electronics and fan (option)

The power supply for the electronics (auxiliary supply) may be either

- internal (self-powered, code SELF) or
- external, 115 V or 230 V depending on the product code

Only one terminal (16 for 230 V or 17 for 115 V) is available depending on the product code. Terminal 18 (marked N) must be connected to the neutral of the external supply or to the second phase (if the supply is taken between 2 phases).

The external supply must be **in phase with (or the opposite phase)** the line connection.

Note : This terminal block is also used for the fan power supply for 250 A units

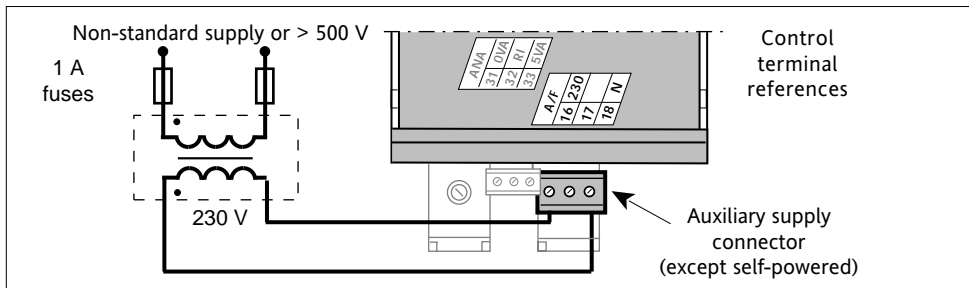

Figure 2-9 Typical 230 V auxiliary power supply connection

2.3.2.4. Alarm relay contact (alarm option)

If one of the alarm options is fitted (Type 1 or Type 2), a relay contact is available on the 'ALARM' terminal block, between terminals 71 and 72 or 73 and 74 (see figure 2-10).

The type of contact (closed or open on alarm) is determined by the product code. Contact switching capacity: 0.25 A (maximum 250 Vac or 30 Vdc).

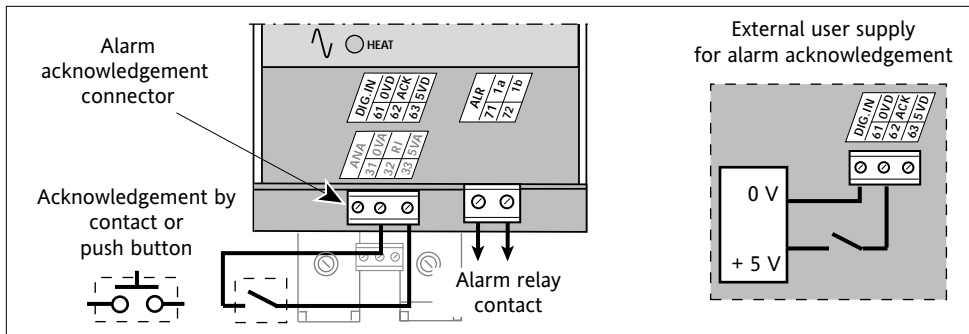

Figure 2-10 Typical alarm relay contact and external acknowledgement connections

2.3.2.5. Acknowledgement signal (ICO option)

With the ICO option, OverLoad and Partial or Total load failure alarms may be acknowledged with a +5 V signal by connecting a contact between terminal 63 (5VD internal) and an ACK logic input (terminal 62) available on the 'DIG.IN' terminal block. An external 5 V supply may be used for this acknowledgement (see figure 2-10).

Note: The DLF alarm can also be reset with the 'CHK/SET' push button.

Chapter 3

FIRING MODES

Contents	Page
3.1. General and firing mode signalling	3-2
3.2. Burst mode (codes C16 and C64)	3-2
Firing delay (XFMR option)	3-3
3.3. Single-cycle (code FC1)	3-4
3.4. Advanced single-cycle (code ASC)	3-4
3.5. Phase angle (code PA)	3-5
3.6. Safety ramp	3-6
3.6.1. Ramp on start-up	3-6
3.6.2. Magnetisation ramp (XFMR option)	3-6

3. Chapter 3 FIRING MODES

3.1. GENERAL AND FIRING MODE SIGNALLING

7300A power thyristor units can be controlled with one of the following thyristor firing types:

- thyristor firing angle variation ('Phase angle', code PA)
- a series of supply voltage cycles with zero crossing firing ('Burst mode', codes C16, C64, FC1, ASC)

Two indicators (green 'ON' and 'HEAT' LEDs) are included on the front panel in all versions, either basic or with options.

The indicators correspond to the thyristor firing mode as shown in the table below.

LED labelling	Signalling
	Power supply for electronics. Power supply fault (flashing). No reference Neutral (flashing).
	Thyristor firing request in 'Burst mode', 'Single-cycle' and 'Advanced single cycle' modes. Reminder: 'Advanced single-cycle' is only available with 4S and 6D three phase load configuration.
	Thyristor firing request in 'Phase angle' mode.

Table 3-1 Firing modes and base LEDs on front panel

During normal operation with zero-crossing switching, the 'HEAT' LED flashes to match the thyristor firing periods.

In normal operation in 'Phase angle' mode, the 'HEAT' LED varies in brightness depending on the firing angle, with maximum brightness during full firing.

3.2. BURST MODE (codes C16 and C64)

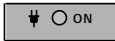
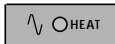
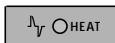
'Burst mode' firing is a **proportional cycle** which delivers a series of **whole supply cycles** to the load. Thyristor firing and cut-off is synchronised with the supply and occurs at **zero** crossing.

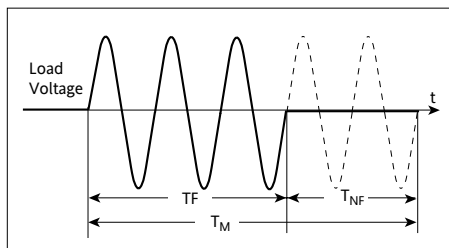

Figure 3-1 Thyristor firing for one of the phases, in 'Burst mode'

Thyristor firing in 'Burst mode' can be described by the firing time (T_F), non-firing time (T_{NF}) and modulation time (T_M) where $T_M = T_F + T_{NF}$ and the Base Cycle Time is equal to the **number of cycles** firing at 50% of the duty ratio (or 50% of the power supplied to the load): $T_B = T_F = T_{NF}$.

The Base Cycle time is equal to **16 cycles** for code **C16** and **64 cycles** for code **C64**.

FIRING DELAY (XFMR option)

In 'Burst mode' firing with pure resistive loads, the thyristors are fired at zero voltage crossing to avoid sharp current rises.

For an **inductive load** (e.g. transformer primary), switching the thyristors at zero crossing generates transient over-currents (see figure 3-2a).

This transient could cause the high speed thyristor protection fuse to blow in certain cases.

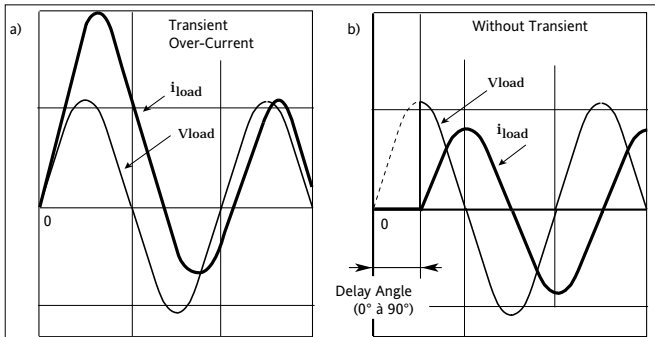
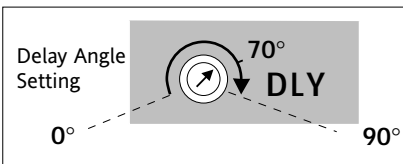

Figure 3-2 Typical switching with inductive load, at zero crossing (a) and with delay (b)



To avoid the over-current, the **first thyristor firing** must be **delayed** relative to the corresponding zero for each phase. The **delay** before thyristor firing starts may be adjusted with the 'DLY' potentiometer available with the **XFMR** option (C16 or C64 'Burst mode').

Figure 3-3 First firing delay adjustment potentiometer (XFMR option)

The 'DLY' potentiometer is a 3/4 turn type, and is used to set the delay angle for the first firing:

- from **0°** (turned anticlockwise to end stop)
- to **90°** (turned clockwise to end stop).

The factory setting for the first firing delay with the XFMR option is **70°** (typical value suitable for starting most applications).

The optimum firing angle can be adjusted with the 'DLY' potentiometer to match the **cos φ** of the load to obtain a minimal transient over-current (using an oscilloscope).

3.3. SINGLE-CYCLE (code FC1)

'Burst mode' firing with a single firing or non-firing cycle is known as 'Single-cycle'.

For example, with a setpoint of 50% (corresponding to a duty ratio $\eta = 50\%$) the modulation comprises 1 firing cycle and 1 non-firing cycle.

For duty ratios $\eta < 50\%$ the **firing** time remains **unchanged** (1 cycle) and the non-firing time increases.

For duty ratios $\eta > 50\%$ the **non-firing** time remains **unchanged** (1 cycle) and the firing time increases.

3.4. ADVANCED SINGLE-CYCLE (code ASC)

In order to **reduce power fluctuations** during firing time, 'Advanced single-cycle' thyristor firing mode uses:

- a whole number of **cycles** for firing, and
- a whole number of **half-cycles** for non-firing, and.

Important: 'Advanced single-cycle' firing mode is **only** available for **4S** or **6D** three-phase load configuration.

For duty ratios $\eta < 50\%$: - the thyristor firing time is **set to one cycle**
 - non-firing occurs for half-cycles.

For duty ratios $\eta > 50\%$: - the non-firing time is **set to half a cycle**,
 - firing occurs for whole cycles.

By using **half-cycles** for non-firing time, the modulation time is reduced compared with standard 'Single-cycle' mode, which is equivalent to burst mode with one cycle. 'Advanced Single Cycle' mode (Code ASC) **reduces flicker** on short wave infrared elements and is thus less annoying on the eyes.

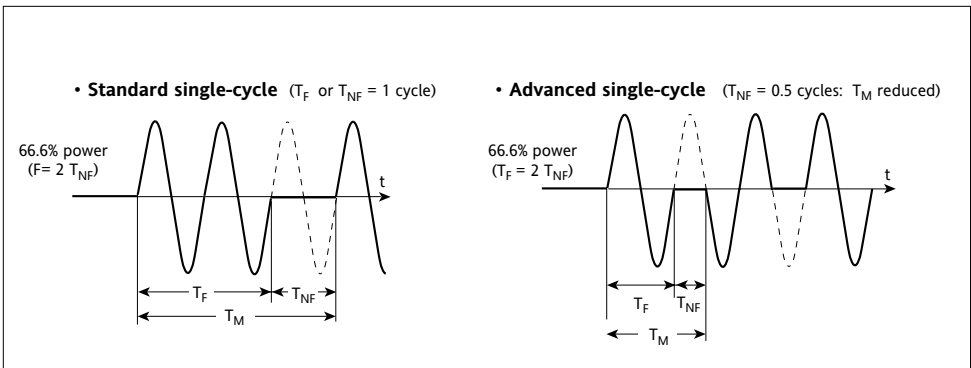

Figure 3-4 Example of Single-cycle and Advanced single-cycle firing mode

3.5. PHASE ANGLE (Code PA)

In 'Phase angle' mode the power delivered to the load is controlled by firing the transistors over a part of each supply half-cycle. Control involves varying the thyristor **firing angle** (θ). It varies with the setpoint signal.

The load voltage (v_l) and current (i_l) depend on the three-phase load configuration.

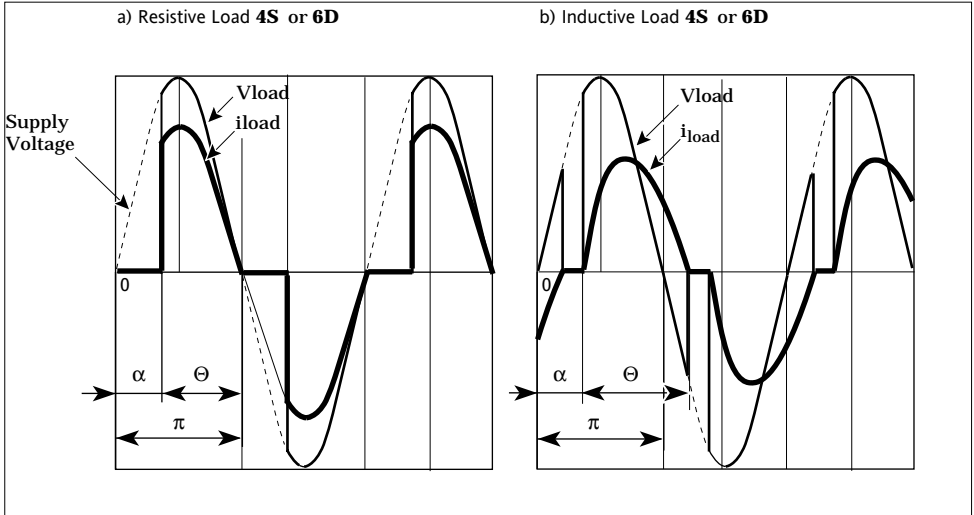

Figure 3-5 Voltage and current in 'Phase angle' mode
a) - resistive load; b) - inductive load.

3.6. SAFETY RAMP

The safety ramp involves progressively increasing the thyristor firing angle in order to apply the voltage (and current) to the load smoothly and thus reduce the start-up current of loads which have a low resistance when cold and inductive loads.

'Phase angle' mode allows the firing angle to be progressively varied on start-up, acting as a **safety ramp**.

3.6.1. Start-up ramp

The start-up ramp is **active** in the following firing modes:

- 'Phase angle' (codes **V2CL** and **VICL + PA**)
- '16-cycle Burst mode' with current limit (codes **C16 + V2CL** or **VICL**).

The start-up ramp (approx. 16 cycles) is applied on the first firing after the thyristor unit is powered up and after the firing is cut for more than 5 seconds. The initial firing angle is approx. 6°.

After the ramp, the firing angle corresponds to the setpoint in 'Phase angle' mode; in 'Burst mode' the thyristors fire fully once the ramp is complete.

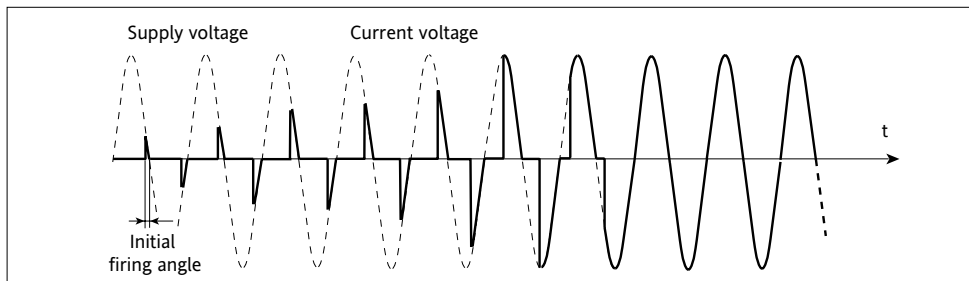

Figure 3-6 Start-up ramp (resistive loads)

3.6.2. Magnetisation ramp (XFMR option)

For inductive loads, the safety ramp prepares initial magnetisation.

To avoid saturating transformers on power up, the safety ramp acts as a magnetisation ramp. With the XFMR option, after this ramp, the first 'burst mode' firing cycle starts with the first firing delay.

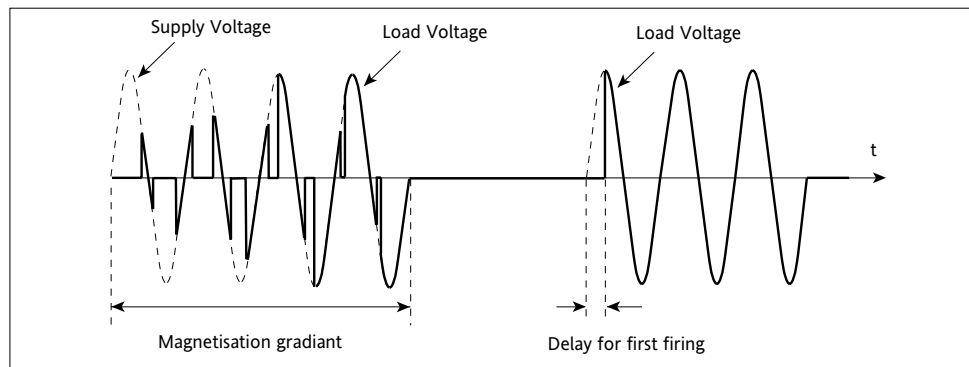

Figure 3-7 Transformer primary power-up in 'Burst mode' (XFMR option)

Chapter 4

4. CONTROL AND LIMITS

Contents	Page
4.1. Control	4-2
4.1.1. Control parameters	4-2
4.1.2. Input / Output ratio	4-2
4.2. Limitation adjustment(options)	4-3
4.2.1. Current recalibration (options without power control) ...	4-4
Settings	4-4
Settings with ICO option	4-4
4.2.3. Current and power limitation	4-5
4.3. Current and power specifications (options)	4-5

4. Chapter 4 CONTROL AND LIMITS

4.1. CONTROL

4.1.1. Control parameters

7100A power thyristor units use one of the following control parameters:

- rms load voltage squared V^2
- rms load current squared I^2
- power delivered to load P
- Open Loop **OL**

The parameters are defined and explained in the table below:

Control Code	Definition
V2	Compensation of supply voltage variations
V2CL	Compensation of supply voltage variations with current limit
VICL	Power control with current and power limits
I2	Current squared control Only available with Phase Angle Mode (code PA)
OL	Open loop, no control. The output is the image of the setpoint Only available with Phase Angle Mode (code PA)

Tableau 4-1 Control parameter use

For the Base version (with no options) the **standard** control parameter is V^2 .

The control parameter must be selected when ordering and forms part of the product code.

4.1.2. INPUT / OUTPUT RATIO

The value of the control **parameter** is **proportional** to the analogue setpoint signal between 4% and 96% of the scale (see figure 4-1).

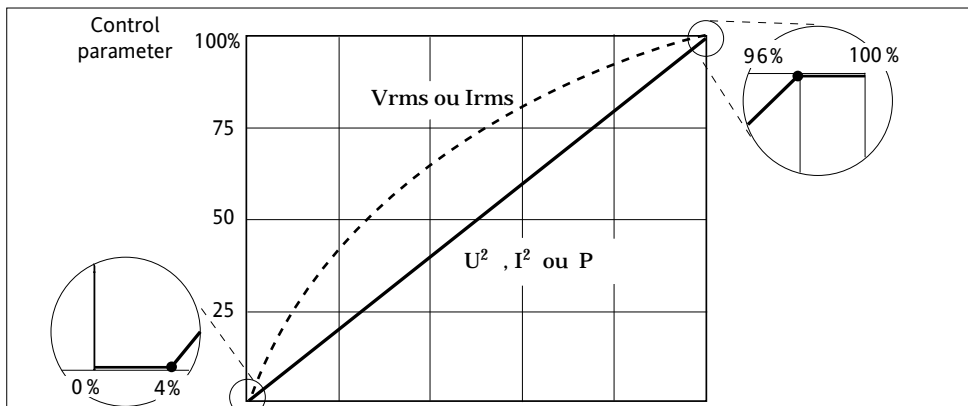

Figure 4-1 Ratio between control system input and output

The ratio between the setpoint and the control parameter (V^2 , I^2 or P) is **linear**.

Four types of input signal are available in the thyristor unit product codes:

0 - 20 mA or 4 - 20 mA, 0 - 5 V or 0 - 10 V.

4.2. LIMITATIONS ADJUSTEMENT (options)

The thyristor units are factory-calibrated to their nominal value: I_N and $P_N = V_N \cdot I_N$

The limits can be adjusted by adjusting the values with the 'I lim' (multi-turn) and 'VI lim' (3/4 turn) potentiometers on the front panel.

4.2.1. CURRENT LIMITATION (options without V-I control)

The 'I lim' potentiometer enables to limit the load current to a chosen value.

The active state of the current limitation is indicated by a green flashing LED 'Ilim'

The new current value I_{max} can be recalibrated between **20%** and **100%** of I_N .

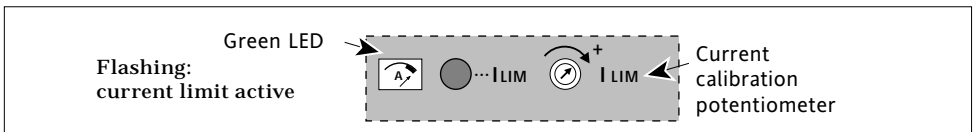

Current setting

1. Turn the 'I lim' potentiometer fully round in the opposite direction to the arrow ($I_{max} = 20\%$ of I_N).
2. Set the thyristor unit firing with **100% setpoint**.
3. Measure the current value and use the 'I lim' potentiometer to set the desired value of I_{max} (new thyristor unit rating).

Current setting with ICO option

In 'Burst mode' with the ICO option the 'I lim' potentiometer is used to set the over-load alarm (see page 5-8).

Over-load detection is signalled by flashing the red 'ICO' LED.

To adjust the setting:

1. Turn the 'I lim' potentiometer fully round in the direction of the arrow ($I_{max} = 100\%$ of I_N).
2. Set the thyristor unit firing with **100% setpoint**.
3. Rotate the 'I lim' potentiometer (**one turn at a time** at 5 second intervals) in the opposite direction to the arrow until the 'ICO' indicator starts flashing.
4. Rotate the potentiometer in the direction of the arrow by approx. **2 turns** and **acknowledge** the alarm (settings-calibration for the nominal load current used).

Important: If spurious alarms occur rotate the 'I lim' potentiometer in the direction of the arrow, **one turn at a time**, until the alarms cease.

4.2.2. CURRENT AND POWER LIMITATION

With the control option VICL, the following are available:

- 'I lim' current calibration potentiometer
- 'VI lim' power calibration potentiometer
- HRC calibration control signal on the 'ADJ.CAL' terminal block

Recalibration is possible:

- current I_{\max} from **20%** to **100%** of I_N
- power P_{\max} from **50%** to **100%** of $(V_N \cdot I_{\max})$.

The **HRC** setting control signal ('ADJ.CAL' terminal block) can be used to aid setting with the 'I lim' and 'VI lim' potentiometers whether or not the thyristor unit is firing.

Setting current and power limitation

The value of the DC voltage between terminals **HRC** (67) and **0VC** (66) represents:

- The **image** of the maximum **current** ('VI lim' potentiometer fully turned in the direction of the arrow)
- The **image** of the maximum recalibrated **power** (1 V corresponds to **100%** P_N).

The control signal is equal to **1 V** if calibrations are **nominal** ($I_{\max} = I_N$ and $P_{\max} = P_N$).

The minimum value of the signal is **0.1 V** ($I_{\max} = 20\%$ and 'VI lim' set to 50% of $V_N \cdot I_{\max}$).

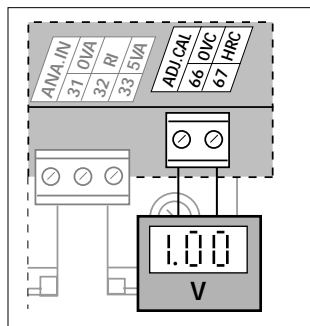

Setting:

1. Turn the 'VI lim' potentiometer fully round in the direction of the arrow (nominal power).
2. Use the 'I lim' potentiometer to set the I_{\max} value.
3. Use the 'VI lim' potentiometer to set the P_{\max} value.
Check the resulting power setting on the **HRC** signal (accounting for I_{\max}).

Important:

The current limitation must be done before adjusting the power limitation.

4.3. CURRENT AND POWER LIMIT SPECIFICATIONS

The table below summarises the operation of the limits used in the 7100A series power thyristor units.

Firing mode	Control type	Potentiometer		Operation of limit
		Name	Action	
C16	V2CL	I lim	Thyristor unit current recalibration: set threshold I_{max}	Current limit by threshold. If the maximum of the three currents $I_M > I_{max}$: firing angle variation. V2 control in 'Burst mode 16'
	VICL	I lim	Thyristor unit current recalibration: set threshold I_{max}	Current limit by threshold. If the maximum of the three currents $I_M > I_{max}$: firing angle variation. P control in 'Burst mode 16'
		VI lim	Recalibration of power control loop: set ratio between P and setpoint	Power limit by control in 'Burst mode 16' taking P_{max} into account
PA	V2CL	I lim	Thyristor unit current recalibration: set ratio between I (%) and setpoint	Current limit by transfer. If the maximum of the 3 currents squared $I_M^2 > V^2$ (%): automatic transfer to I^2 control by firing angle variation.
		I lim	Thyristor unit current recalibration: set ratio between I (%) and setpoint	Current limit by transfer. If the maximum of the 3 currents squared $I_M^2 > V^2$ (%): automatic transfer to I^2 control by firing angle variation.
	VI lim	Recalibration of power control loop: set ratio between P and setpoint	Power limit by control (variation of firing angle; new ratio between P and setpoint.	
	I^2	I lim	Thyristor unit current recalibration: set ratio between I (%) and setpoint	Current limit by transfer. If $(I_M^2) - (I_{Min}^2) > 25\% I_N^2$: automatic transfer to I_M^2 .

Table 4-2 Operation of current and power limits

Reminder: Recalibration sets the unit's new nominal current rating (I_N).

Chapter 5

ALARMS

Contents	Page
Alarm diagnostic summary	5-2
5.1. Safety mechanisms	5-3
5.2. Alarm strategy	5-3
5.2.1. Firing cut-off	5-3
5.2.2. Alarm priority	5-3
5.2.3. Memorisation	5-3
5.3. Load Monitoring	5-4
5.3.1. Setting the DLF alarm	5-5
5.3.2. PLF or TLF detection	5-5
5.3.3. PLF detection sensitivity	5-5
5.4. Load type matching	5-5
5.5. Disabling alarms for load failure signalling	5-5
5.6. Functions of DLF alarm push button	5-6
5.6.1. Setting Request	5-6
5.6.2. Diagnostic	5-6
5.6.3. Disabling	5-6
5.7. Over Load Alarm	5-7
5.7.1. Availability	5-7
5.7.2. Alarm conditions	5-7
5.7.3. Alarm Actions, Memorisation, Acknowledgement ..	5-7

ALARM DIAGNOSTIC SUMMARY

The table below summarises all status LED information needed to **diagnose the fault**.





























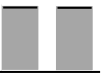

OPTIONS :	All versions	ICO	Alarm options	GRF	DLF		
 -T°  ...ICO Red			250 A				
 GRF Red							
 DLF Orange							
 ON Green							
 HEAT Green Or							
 HEAT Green							
DIAGNOSTIC:	↓	↓	↓	↓	↓	↓	↓
	No firing alarm: Phase angle or zero crossing	Over-current. Firing inhibited (see page 5-7)	Over-temperature. Firing inhibited	Thyristor short-circuit or Total load failure	Thyristor short-circuit	Total load failure	Partial load failure

Figure 5-1 Diagnosing operation and alarms according to front panel LED status

Chapter 5 ALARMS (Options)

5.1. SAFETY MECHANISMS

The alarms on the 7100A protect the thyristors and the load against certain types of abnormal operation and provide the user with information about the type of fault.



Danger

- Alarms are not under any circumstances a replacement for personnel protection.
 - The user is responsible for installing independent safety mechanisms which must be inspected regularly. Given the value of the equipment controlled by the 7100A, this is strongly recommended.
- Eurotherm can supply various types of suitable alarm detector.

5.2. ALARM STRATEGY

- **Load monitoring** (option) : monitoring of load and thyristors
- **Over Load Alarm** (option) : protection against exceeding a current threshold

In addition , the unit has active securities :

- Network voltage default detection
(no network or supply voltage not high enough and frequency error)
- Over temperature protection (fan cooled units, 250 A only)

5.2.1. Firing cut-off

- 'Over-Load'
- 'Overheating' (for current ratings **250 A** only)
- 'Supply voltage' stops the thyristor firing

5.2.2. Alarm priority

Only one alarm is signalled if several faults occur simultaneously. Over load and standard alarms, thermal faults and thyristor short-circuits **take priority** over load fault display.

5.2.3. Memorisation

Load monitoring and standard alarms are **not memorised**.

After an alarm has been detected, and once the fault conditions have cleared, signalling for these alarms (LED and relay) returns to the non-alarm position.

OverLaod alarm is memorised and must be acknowledged Thyristor short-circuit and neutral cut-off require repairs.

5.3. LOAD MONITORING

Two diagnostic options are available :

- GRF option (Gross Fault) which permits to detect the following serious faults :
Total Load Failure : TLF
Thyristor Short-Circuit : THSC
Over Heating : T° (for units 250 A only)
- DLF option (Diagnostic Load Failure), presents the same fault detection as GRF option with in addition, the Partial Load Failure detection (PLF).

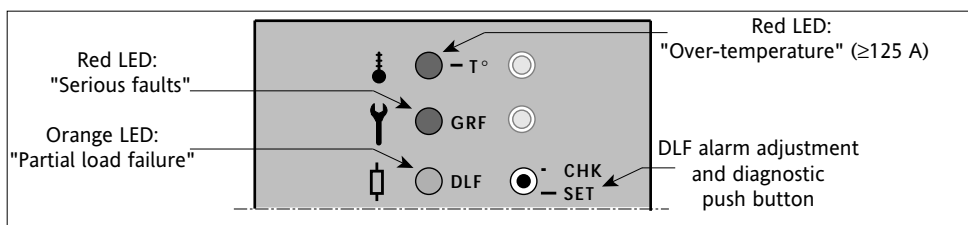

Figure 5-2 Layout of front panel LEDs with 'GRF' and/or 'DLF' option

Fault	LED State				Firing stopped	Temps de réaction typique
	'T°' red	'GRF' red	'DLF' orange	'HEAT' green		
Partial Load Failure (PLF)	OFF	OFF	Flashing	ON or Flashing	No	5 s to 13 s
Total Load Failure (TLF)	OFF	ON	Flashing			
Thyristor Short-Circuit (THSC)	OFF	ON	OFF			
Over-temperature (T°)	ON	OFF	OFF	OFF	Yes	

Table 5-1 LEDs for serious alarms or faults with 'GRF'and/or 'DLF' options

Note: • Thermal faults are **signalled** by the 'T°' LED if one of the alarm options or one of the control options (except V2 and OL) is fitted. The unit is **protected** against thermal faults whether or not they are signalled. Thermal faults are signalled by the alarm relay **if** one of the alarm options is fitted.

5.3.1. Setting the DLF alarm

This can be set using the push button on the front panel. The PLF detection setting can only be adjusted (reference impedance recalculated) in the following conditions :

- rms voltage across load is greater than **40** % of the nominal voltage
- rms current is greater than **30%** of the rated current
- no over-temperature or thyristor short-circuit faults.
- in order to guarantee the full scale sensitivity, settings must be done at the load's nominal temperature

Note : PLF settings stay memorised even if a supply cut-out occurred

5.3.2. Partial or Total Load Failure Detection

PLF detection is only possible under the following conditions :

- no over-temperature or thyristor short-circuit faults.
- rms voltage across the load greater than **40%** of the nominal voltage and,
- rms load current greater than **5%** of the rated current.

Total Load Failure TLF monitoring is only possible under the following conditions :

- no over-temperature or thyristor short-circuit faults.
- the rms voltage across load is greater than **40** % of the nominal voltage

5.3.3. Partial Load Failure Detection Sensitivity

Partial Load Failure Detection Sensitivity can be expressed in terms of a **maximum number** of load elements connected in parallel for which the unit can detect the failure of one element. The DLF sensitivity guaranteed for 1 element out of 6.

5.4. Load type matching

PLF detection is **adapted** to the load type.

The type of load controlled is selected when ordering, with the product code:

- **LTCL** (Low Temperature Coefficient Load), or
- **SWIR** (Short Wave InfraRed elements).

5.5. Disabling alarms for load failure signalling

PLF fault signalling ('DLF' indicator and relay) can be temporarily **excluded** from alarms by pressing the '**CHK / SET**' (**C**heck / **S**etting) push button.

If the fault persists, DLF signalling returns to the alarm position.

If the **ICO** option is used, PLF and TLF faults can be **excluded** from alarms using the external acknowledgement logic input (see "Type 2 alarm").

5.6. Functions of DLF alarm push button

The push button on the front panel of the unit with the 'DLF' option is labelled 'CHK / SET' (Checking / Setting).

Pushing this push button as shown on the diagrams below sets and diagnoses the status of the PLF detection circuit.

5.6.1. Setting request

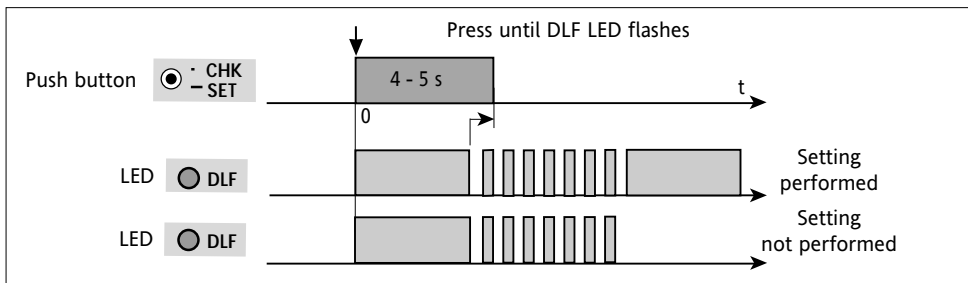

Figure 5-3a PLF detection setting request

5.6.2. Diagnostic

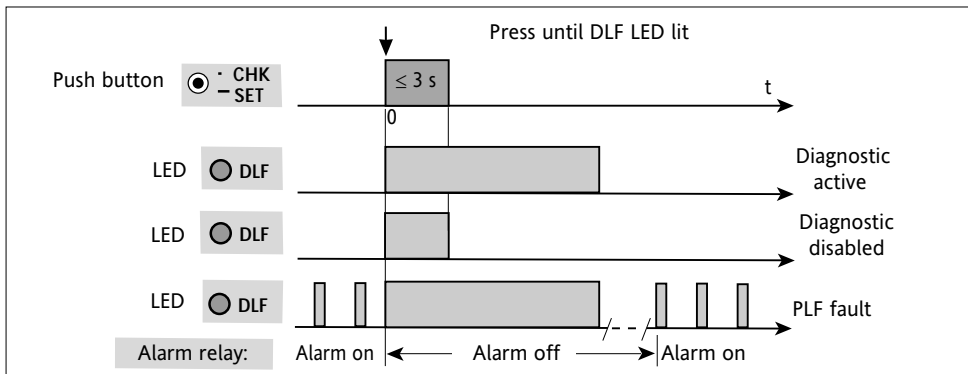

Figure 5-3b PLF monitoring diagnosis

5.6.3. Disabling

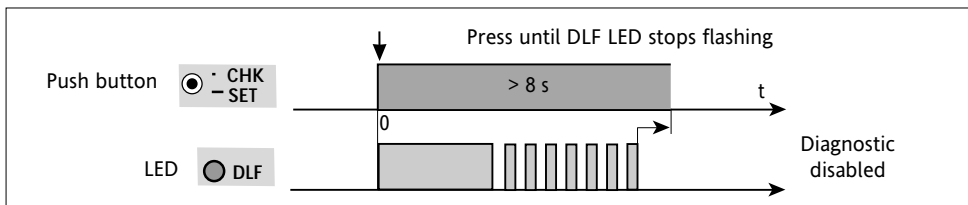

Figure 5-3c Disabling PLF monitoring

5.7. OVERLOAD ALARM (ICO option)

The type 2 alarm (**Over-current** alarm) monitors the maximum current value. This alarm (and option) is known as **ICO (Intelligent Chop Off)**.

5.7.1. Availability

The ICO option is available in **zero-crossing** firing modes ('Burst mode' and 'Single-cycle') provided the **DLF** option is fitted.

The ICO option is not available for short wave infrared elements and transformers (code SWIR or XFMR), or in control with current limit (code V1CL or V2CL).

5.7.2. Alarm conditions

With the ICO option an **Over load** fault is detected if one of the following two conditions occurs:

- the **instantaneous** current on one phases exceeds a threshold of **150%** of the instantaneous rated current ($1.5 \sqrt{2} I_{max}$)
- the **rms** load current (over 5 consecutive seconds) on the phase exceeds a threshold of 110% of the recalibrated rms current ($1.1 I_{max}$).

The instantaneous or rms current threshold can be adjusted with the '**I lim**' potentiometer during the current calibration phase, from 20% to 100% of the nominal current for the thyristor unit.

5.7.3. Alarm Actions, Memorisation, Acknowledgement

If an over-current alarm is triggered, thyristor firing **stops**:

- at the end of the half-cycle when the instantaneous current threshold is exceeded
- after approx. 5 s of continuously exceeding the rms current threshold.

Over-current alarm cut-off is signalled as follows:

- the position of the Alarm relay **contact** changes
- the '**...ICO**' LED **flashes** (and turns red).

Important:

- The '**ICO**' LED starts flashing as soon as the rms current **exceeds** the threshold; i.e. **5 s before** firing may be cut off.
- **Setting** the Over-current alarm threshold in operating conditions is described on **page 4-4**.

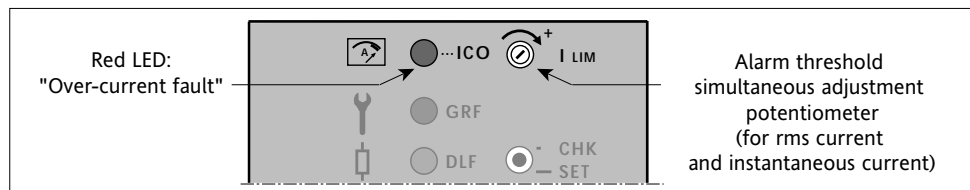

Figure 5-4 Layout of the 'ICO' LED and 'I lim' potentiometer with the ICO option

The over-current alarm cut-off is **memorised**.

The thyristor unit remains cut off and signals the alarm status.

The Over-current alarm may be **acknowledged** by applying **+5 V** to the '**ACK**' terminal on the '**DIG.IN**' terminal block (logic signal inputs). The internal supply ('**5VD**' terminal) or an external source may be used to acknowledge the alarm remotely (see figure 2-12).

Chapter 6

MAINTENANCE

Contents	Page
6.1. Safety during maintenance	6-2
6.2. Maintenance	6-2
6.3. Thyristor protection fuses	6-2

Chapter 6 MAINTENANCE

6.1. SAFETY DURING MAINTENANCE

Please read carefully before commissioning the thyristor unit

Important!



- Eurotherm shall not be held responsible for any damage, injury, losses or expenses caused by inappropriate use of the product or failure to comply with this manual.
- Accordingly the user is responsible for checking, before commissioning the unit, that all the nominal characteristics correspond to the conditions under which it is to be installed and used.

Danger!



- The product must be commissioned and maintained by qualified personnel, authorised to work in an industrial low voltage environment. Users must not attempt to access internal parts. The heatsink temperature may exceed 100°C. The heatsink remains hot for approx. 15 minutes after the unit is shut down. Avoid touching the heatsink even briefly while the unit is operating.

6.2. MAINTENANCE

- Every six months, check that the power and protective earth cables are correctly tightened (see 'Wiring' section, page 2-7).
- If the load parameters change, the operation of the PLF detection must be diagnosed (see 'DLF option' section).
- If a DLF alarm occurs, check the load wiring and condition of contacts. Use the push button to confirm the DLF alarm diagnosis (see page 5-6).
- To ensure that the unit is cooled correctly, the heatsink should be cleaned regularly, depending on how dirty the environment is, as should the fan protection grille for fan-cooled units rated at 250A).

Danger!



The thyristor unit should be cleaned only when powered down, at least 15 minutes after stopping operation.

6.3. Thyristor protection fuses

The thyristors in the 7100A power thyristor unit are protected against excess currents by a high-speed fuse (for all load types other than short wave infrared elements).

For current ratings ≤ 100 A the fuse is external.

Important! To use high-speed fuses with short wave infrared elements, please contact your Eurotherm office.

Danger!



High-speed fuses do not provide protection for the installation. Upline protection must be fitted (non-high-speed fuses, circuit breakers, cut-outs).

The product code specifies whether or not a fuse is present.

With the FUSE or MSFU (micro switch fuse) codes, a fuse and fuse holder assembly (corresponding to the current rating) is supplied with the product.

- for code FUSE , the fuse is not fitted with a striker bar.
- for code MSFU, the fuse has a striker bar and the fuse holder is fitted with a blown fuse microswitch.

If the user does not order a thyristor protection fuse or if a short wave infrared load is used, no fuse is supplied (code NONE).

Rating	Fuse reference	Fuse and fuse-holder assembly	
		Reference	Dimensions (mm) H x W x D
16 A	CH260024	FU1038/16A	81 x 17.5 x 68
25 A	CH260034	FU1038/25A	81 x 17.5 x 68
40 A	CH330054	FU1451/40A	97 x 26.5 x 86
63 A	CS173087U080	FU2258/63A	128 x 35 x 90
80 A	CS173087U100	FU2258/80A	128 x 35 x 90
100 A	CS173246U125	FU2760/100A	240 x 38 x 107
125 A	CS176762U160	FU7100/125A	Internal FUSE
160 A	CS176762U250	FU7100/160A	
200 A	CS176762U315	FU7100/200A	
250 A	CS176762U315	FU7100/250A	

Table 6-1 Fuses without microswitch, recommended for ratings 16 A to 250 A (code FUSE)

Rating	Fuse reference with striker bar	Fuse and fuse holder assembly with microswitch	
		Reference	Dimensions (mm) H x W x D
16 A	CS176513U020	MSFU1451/16A	110 x 26.5 x 94
25 A	CS176513U032	MSFU1451/25A	110 x 26.5 x 94
40 A	CS176513U050	MSFU1451/40A	110 x 26.5 x 94
63 A	CS176461U080	MSFU2258/63A	127,5 x 35 x 96,5
80 A	CS176461U100	MSFU2258/80A	127,5 x 35 x 96,5
100 A	CS173246U125	MSFU2760/100A	240 x 53 x 107
125 A	CS176762U160	MSFU7100/125A	Internal FUSE
160 A	CS176762U250	MSFU7100/160A	
200 A	CS176762U315	MSFU7100/200A	
250 A	CS176762U315	MSFU7100/250A	

Table 6-2 Fuses with microswitch, recommended for ratings 16 A to 250 A (code MSFU)

Important!

For all loads (other than short wave infrared elements), using a thyristor protection fuse **other than the recommended fuse** voids the product guarantee.

Notes :

EUROTHERM

For over thirty years **Eurotherm Limited** have been providing an unparalleled level of service and expertise to customers in the control of Processes and Power.

From requirement assessment, through to equipment specification and plant commissioning.

Eurotherm Limited is able to offer expertise and equipment in the following areas:

- Input conditioning
- Process and Temperature Indicators
- Single Loop Process and Temperature Controllers with Programming facilities
- Programmable Multi loop Process Controllers
- Solid State Contactors
- Power Controllers
- Paper and Paperless Data Recorders
- Data Acquisition and Management Instrumentation
- Supervisory Systems (SCADA)
- Process Automation Systems

Eurotherm Limited is part of the **Production Management Division** of **Invensys plc**, one of the world's leading automation and controls companies.

Eurotherm manufactures at a number of locations in Europe and the USA, and is a major supplier to the world's processing and manufacturing industries.

The company is ISO9000 approved and operates TickIT protocols for software management.

Please contact your local **Sales Office**.