

000

ENG

3200

User Guide

PID Temperature
controllers



Invensys

EUROTHERM

This booklet includes:

User Guide (HA028582 Issue 5)

Manuel Utilisateur (HA028582FRA Indice 5)

Bedienungsanleitung (HA028582GER Ausgabe 5)

3200 Series PID Temperature Controllers

Applies to Model numbers 3216, 3208, 32h8 and 3204

Contents

1.	What Instrument Do I Have?	4
1.1	Unpacking Your Controller	4
1.2	Dimensions.....	5
1.3	Step 1: Installation	7
1.3.1	Panel Mounting the Controller.....	7
1.3.2	Panel Cut-out Sizes.....	7
1.3.3	Recommended minimum spacing of controllers. Applies to all Model sizes	8
1.3.4	To Remove the Controller from its Sleeve	8
1.4	Ordering Code	9
2.	Step 2: Wiring	10
2.1	Terminal Layout 3216 Controller.....	10
2.2	Terminal Layout 3208 and 3204 Controllers	11
2.3	Terminal Layout 32h8 Controller	12
2.4	Wire Sizes	13
2.5	Sensor Input (Measuring Input)	13
2.6	Input/Output 1 & Output 2	14
2.7	Remote Setpoint Input.....	15

2.8	Output 3	15
2.9	Output 4 (AA Relay)	16
2.10	Digital Inputs A & B	17
2.11	Transmitter Power Supply	17
2.12	Current Transformer	18
2.13	Digital Communications	19
2.14	Controller Power Supply.....	21
2.15	Example Wiring Diagram	21
3.	Safety and EMC Information	22
3.1	Installation Safety Requirements.....	23
4.	Switch On	27
4.1	Initial Configuration	27
4.2	To Re-Enter Quick Code configuration mode	30
4.3	Pre-Configured Controller or Subsequent Starts	30
4.4	Front panel layout.....	31
4.4.1	To Set The Target Temperature (setpoint).....	32
4.4.2	Alarm Indication	32
4.4.3	Auto, Manual and Off Mode.....	32
4.4.4	To Select Auto, Manual or OFF Mode	33
4.4.5	Operator Parameters in Level 1	34
5.	Operator Level 2	35
5.1	To Enter Level 2.....	35
5.2	To Return to Level 1	35
5.3	Level 2 Parameters	35

5.4	Timer Operation	44
5.5	Dwell Timer	45
5.6	Delayed Timer	46
5.7	Soft Start Timer	47
5.8	Programmer	48
5.8.1	Programmer Servo Mode and Power Cycling.....	49
5.8.2	To Operate the Programmer.....	50
5.8.3	To Configure the Programmer	51

Issue 5 of this User Guide applies to software versions 2.09 and above for PID controller and 2.29 and above for Valve Position controllers.

Issue 5 of this User Guide includes:-

- Remote Setpoint Input Option RCL
- Programmer Cycles
- RS422 4-wire Digital Communications, Option 6XX available in 3216 only

Installation and Basic Operation

1. What Instrument Do I Have?

Thank you for choosing this 3200 series Temperature Controller/Programmer.

The 3200 series provide precise temperature control of industrial processes and is available in three standard DIN sizes:-

- 1/16 DIN Model Number 3216
- 1/8 DIN Model Number 3208
- 1/8 DIN Horizontal Model Number 32h8
- 1/4 DIN Model Number 3204

A universal input accepts various thermocouples, RTDs or process inputs. Up to three (3216) or four (3208, 32h8 and 3204) outputs can be configured for control, alarm or re-transmission purposes. Digital communications and a current transformer input are available as options.

The controller may have been ordered to a hardware code only or pre-configured using an optional 'Quick Start' code. The label fitted to the side of the sleeve shows the ordering code that the controller was supplied to. The last two sets of five digits show the Quick Code. If the Quick Code shows *****/*****

the controller will need to be configured when it is first switched on.

This User Guide takes you through step by step instructions to help you to install, wire, configure and use the controller. For features not covered in this User Guide, a detailed Engineering Manual, Part No HA027986, and other related handbooks can be downloaded from www.eurotherm.co.uk.

1.1 Unpacking Your Controller

The following items are included in the box:

- Controller mounted in its sleeve
- Two panel retaining clips
- AN IP65 sealing gasket mounted on the sleeve
- Component packet containing a snubber for each relay output and a 2.49Ω resistor for current inputs (see section 2)
- This User Guide

1.2 Dimensions

The following two pages show general views of the controllers together with overall dimensions.

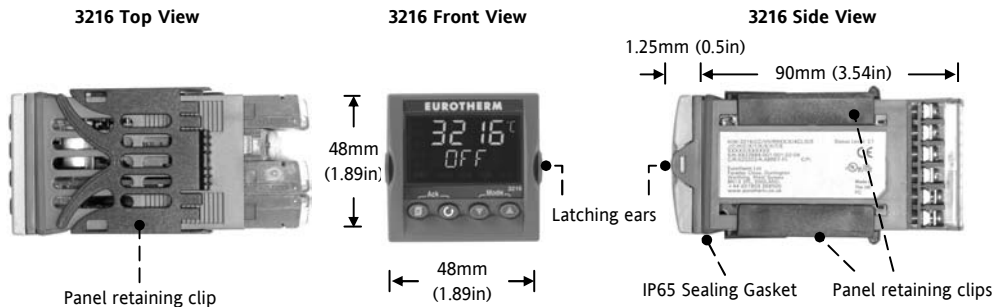

3208 Front



32h8 Front



3204 Front



**32h8 Side
with Panel Retaining Clips**

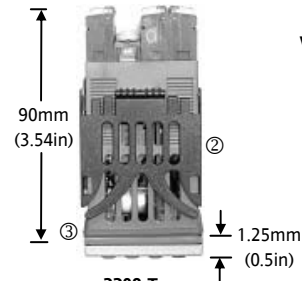

**3208 Top
with Panel Retaining Clip**

- ① Latching ears
- ② Panel Retaining Clip
- ③ IP65 Sealing Gasket

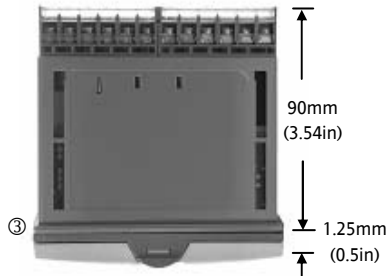

**32h8 and 3204 Top
without Panel Retaining Clip**

1.3 Step 1: Installation

This controller is intended for permanent installation, for indoor use only, and enclosed in an electrical panel

Select a location which is subject to minimum vibrations, the ambient temperature is within 0 and 55°C (32 - 131°F) and humidity 5 to 95% RH non condensing.

The controller can be mounted on a panel up to 15mm thick

To ensure IP65 and NEMA 4 front sealing against dust and water, mount on a non-textured surface. Please read the safety information in section 3 before proceeding. The EMC Booklet part number HA025464 gives further installation information.

1.3.1 Panel Mounting the Controller

1. Prepare a cut-out in the mounting panel to the size shown. If a number of controllers are to be mounted in the same panel observe the minimum spacing shown.
2. Fit the IP65 sealing gasket behind the front bezel of the controller
3. Insert the controller through the cut-out

4. Spring the panel retaining clips into place. Secure the controller in position by holding it level and pushing both retaining clips forward.
5. Peel off the protective cover from the display

1.3.2 Panel Cut-out Sizes

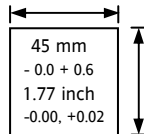

1/16 DIN Cut Out

45 mm - 0.0 + 0.6
1.77 inch -0.00, +0.02

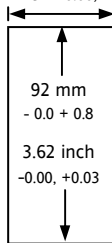

1/8 DIN Cut Out

92 mm - 0.0 + 0.8
3.62 inch -0.00, +0.03

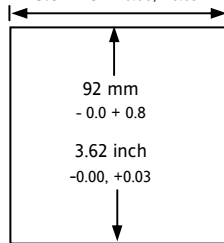

1/4 DIN Cut Out

1.3.3 Recommended minimum spacing of controllers. Applies to all Model sizes

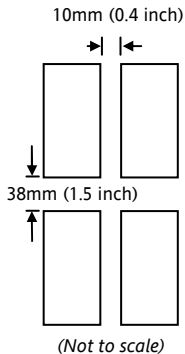

1.3.4 To Remove the Controller from its Sleeve

The controller can be unplugged from its sleeve by easing the latching ears outwards and pulling it forward out of the sleeve. When plugging it back into its sleeve, ensure that the latching ears click back into place to maintain the IP65 sealing.

1.4 Ordering Code

1	2	3	4	5	6	7	8	9	10	11	12	13	Quick Start Code – section 4		
1. Model No.					4. Outputs 1, 2 and 3 3208/H8/04					7. Fascia colour/type					
1/16 DIN size		3216			OP1		OP2		OP3		Green		G		
1/8 DIN size		3208			X		X		X		Silver		S		
1/8 DIN horizontal		32h8			L		R		R		Wash down fascia		W		
1/4 DIN size		3204			R		R		R						
2. Function					L		L		R						
Controller		CC			L		R		D						
Programmer		CP			R		R		D						
valve controller		VC			D		D		D						
Valve programmer		VP			L		L		D						
3. Power Supply					D		R		D						
24Vac/dc		VL			L		T		R						
100–240Vac		VH			L		T		D						
T					T		T		D						
4. Outputs 1 and 2 3216					5. AA Relay (OP4)					10. Extended Warranty					
OP1		OP2			3216		Disabled				Standard		XXXXX		
X		X		X		X		Relay (Form C)		R		Extended		WL005	
L		X		X		X		6. Options				11. Certificates			
L		R		X		X		Not fitted		XXX		None		XXXXX	
R		R		X		X		RS485 & Digital input A		4XL		CERT1		Cert of conformity	
L		L		X		X		RS232 & Digital input A		2XL		CERT2		Factory calibration	
L		D		X		X		RS485, CT & Dig in A		4CL					
D		D		X		X		RS232, CT & Dig in A		2CL					
D		R		X		X		Digital input A		XXL					
L		T		X		X		CT & Digital input A		XCL					
T		T		X		X		Remote SP, CT and Logic IP		RCL					
					4-wire RS485 Comms (3216 only)		6XX		12. Custom Label				13. Specials Number		
									XXXXXX		None		XXXXXX		None
									RES250		250Ω ; 0-5Vdc OP		RES500		500Ω ; 0-10Vdc OP
									RES500		500Ω ; 0-10Vdc OP				

Triac not available with low voltage supply option.

L = Logic; R = Relay; D = DC; T = Triac

2. Step 2: Wiring

2.1 Terminal Layout 3216 Controller

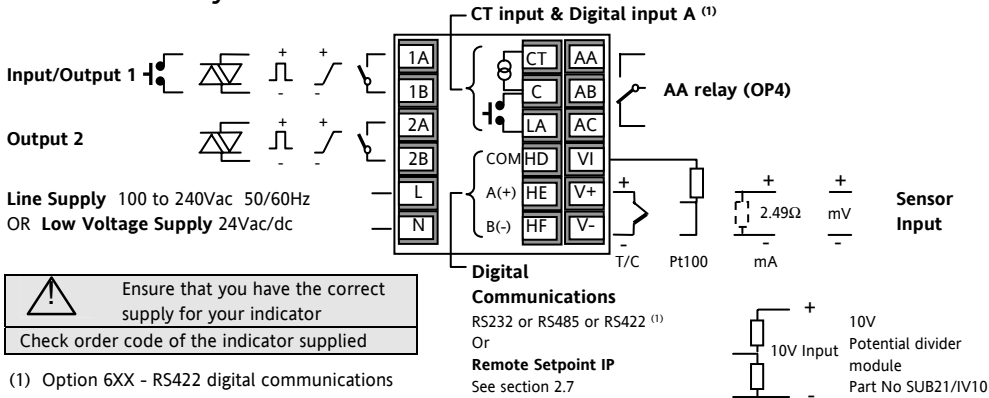







Ensure that you have the correct supply for your indicator

Check order code of the indicator supplied

(1) Option 6XX - RS422 digital communications uses terminals CT to HF.

CT/LA inputs are not available see section 2.13.1.3

Key to symbols used in this and following wiring diagrams

	Logic (SSR drive) output		Relay output		Contact input
	mA analogue output		Triac output		Current transformer input

2.2 Terminal Layout 3208 and 3204 Controllers

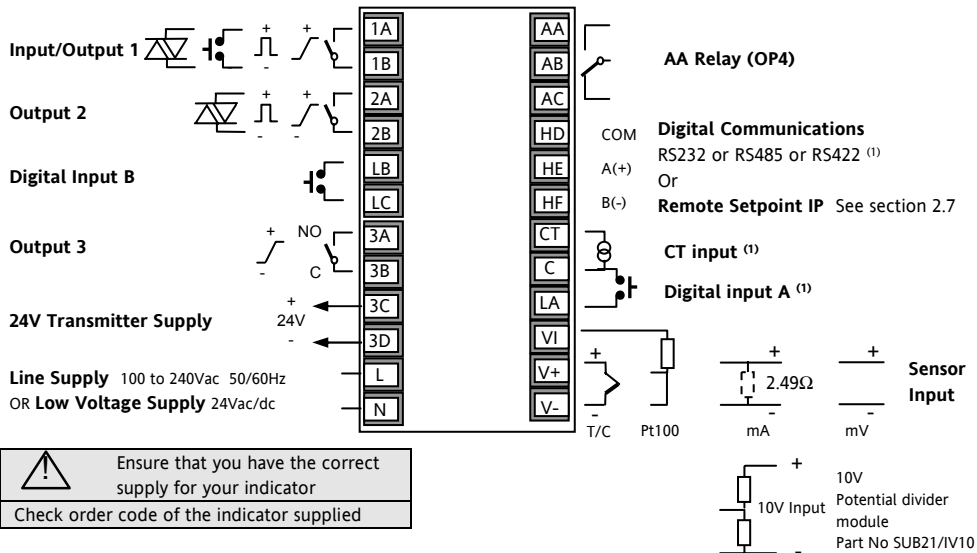

 Ensure that you have the correct supply for your indicator
Check order code of the indicator supplied

2.3 Terminal Layout 32h8 Controller

	Ensure that you have the correct supply for your indicator
Check order code of the indicator supplied	

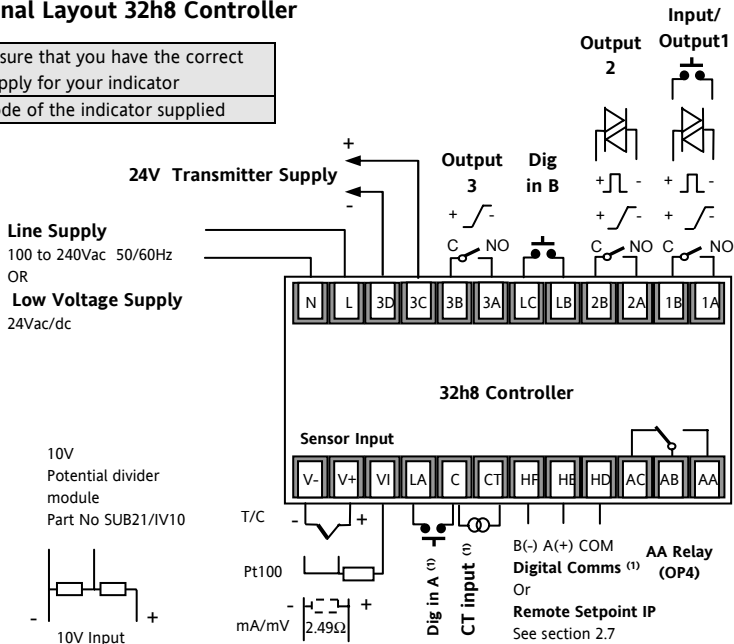

2.4 Wire Sizes

The screw terminals accept wire sizes from 0.5 to 1.5 mm (16 to 22AWG). Hinged covers prevent hands or metal making accidental contact with live wires. The rear terminal screws should be tightened to 0.4Nm (3.5lb in).

2.5 Sensor Input (Measuring Input)

- Do not run input wires with power cables
- When shielded cable is used, it should be grounded at one point only
- Any external components (such as zener barriers) connected between sensor and input terminals may cause errors in measurement due to excessive and/or un-balanced line resistance, or leakage currents.
- Not isolated from the logic outputs & digital inputs

Thermocouple Input

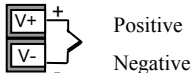

- Use the correct compensating cable preferably shielded.

RTD Input

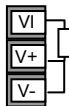

PRT

PRT

Lead compensation

- The resistance of the three wires must be the same. The line resistance may cause errors if it exceeds 22Ω.

Linear mA, mV or Voltage Inputs

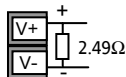

Positive

Negative

- For a mA input connect the 2.49Ω burden resistor supplied between the V+ and V- terminals as shown
- For a 0-10Vdc input an external input adapter is required (not supplied). Part number: SUB21/IV10.

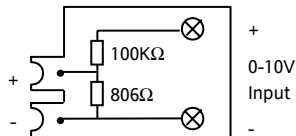

2.6 Input/Output 1 & Output 2

May be configured as input or output.

Outputs can be logic (SSR drive), or relay, or mA dc.

Input is contact closure.

Relay Output (Form A, normally open)

OP1/2



- Isolated output 240Vac CATII
- Contact rating: 2A 264Vac resistive
- Output functions: Heating, or cooling, or alarm or motorised valve open or closed

Logic (SSR drive) Output

OP1/2

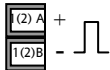

- Not isolated from the sensor input
- Output ON state: 12Vdc at 40mA max
- Output OFF state: <300mV, <100µA
- Output functions: Heating, or cooling, or alarm or motorised valve open or closed
- The output switching rate must be set to prevent damage to the output device in use. See parameter 1.PLS or 2.PLS in section 5.3

DC Output

OP1/2

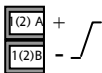

- Not isolated from the sensor input
- Software configurable: 0-20mA or 4-20mA.
- Max load resistance: 500Ω
- Calibration accuracy: \pm (<1% of reading + <100µA)
- Output functions: Heating, or cooling, or retransmission.

Triac Output

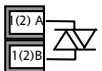

- Isolated output 240Vac CATII
Rating: 0.75A rms, 30 to 264Vac resistive

Logic Contact Closure Input (OP1 only)

OP1



- Not isolated from the sensor input
- Switching: 12Vdc at 40mA max
- Contact open > 500Ω. Contact closed < 150Ω
- Input functions: Please refer to the list in the Quick Start codes.

2.7 Remote Setpoint Input

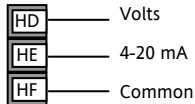

- There are two inputs; 4-20mA and Volts which can be fitted in place of digital communications
 - It is not necessary to fit an external burden resistor to the 4-20mA input
- If the 4-20mA remote setpoint input is connected and valid ($>3.5\text{mA}$; $<22\text{mA}$) it will be used as the main setpoint. If it is not valid or not connected the controller will try to use the Volts input. Volts sensor break occurs at <-1 ; $>+11\text{V}$. The two inputs are not isolated from each other
 - If neither remote input is valid the controller will fall back to the internal setpoint, SP1 or SP2 and flash the alarm beacon. The alarm can also activate a relay if configured or read over digital communications. See Engineering Handbook HA027986
 - To calibrate the remote setpoint, if required, see the Engineering Handbook HA027986
 - A local SP trim value is available in a deeper level of access. See Engineering Handbook HA027986

2.8 Output 3

Output 3 is not available in model 3216. In 1/8 and 1/4 DIN controllers it is either a relay or a mA output.

Relay Output (Form A, normally open)

OP3



- Isolated output 240Vac CATII
- Contact rating: 2A 264Vac resistive
- Output functions: Heating, or cooling, or alarm or motorised valve open or closed

DC Output

OP3

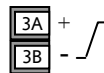

- Isolated output 240Vac CATII
 - Software configurable: 0-20mA or 4-20mA
 - Max load resistance: 500 Ω
 - Calibration accuracy: $\pm(<0.25\%$ of reading + $<50\mu\text{A}$)
- Output functions: Heating, or cooling, or retransmission.

2.9 Output 4 (AA Relay)

Output 4 is always a relay.

Relay Output (Form C)

OP4

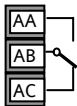

- Isolated output 240Vac CATII
- Contact rating: 2A 264Vac resistive
- Output functions: Heating, or cooling, or alarm or motorised valve open or closed

* General Notes about Relays and Inductive Loads

High voltage transients may occur when switching inductive loads such as some contactors or solenoid valves. Through the internal contacts, these transients may introduce disturbances which could affect the performance of the instrument.

For this type of load it is recommended that a 'snubber' is connected across the normally open contact of the relay switching the load. The snubber recommended consists of a series connected resistor/capacitor (typically 15nF/100Ω). A snubber will also prolong the life of the relay contacts.

A snubber should also be connected across the output terminal of a triac output to prevent false triggering under line transient conditions.

WARNING

When the relay contact is open, or it is connected to a high impedance load, it passes a current (typically 0.6mA at 110Vac and 1.2mA at 240Vac). You must ensure that this current will not hold on low power electrical loads. If the load is of this type the snubber should not be connected.

2.10 Digital Inputs A & B

Digital input A is an optional input in all Model sizes.
Digital input B is always fitted in the Models 3208, 32h8 and 3204.

Dig in A



Dig in B



- Not isolated from the current transformer input or the sensor input
- Switching: 12Vdc at 40mA max
- Contact open > 500Ω. Contact closed < 200Ω
- Input functions: Please refer to the list in the quick codes.

☺ If RS422 digital communications is fitted, Digital Input A is not available.

2.11 Transmitter Power Supply

The Transmitter Supply is not available in the Model 3216. It is fitted as standard in the Models 3208 and 3204.

Transmitter Supply

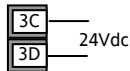

- Isolated output 240Vac CATII
- Output: 24Vdc, +/- 10%. 28mA max.

2.12 Current Transformer

The current transformer input is an optional input in all model sizes.

It can be connected to monitor the rms current in an electrical load and to provide load diagnostics. The following fault conditions can be detected: SSR (solid state relay) short circuit, heater open circuit and partial load failure. These faults are displayed as alarm messages on the controller front panel.

☺ If RS422 digital communications is fitted, Current Transformer Input is not available.

CT Input



Note: Terminal C is common to both the CT input and Digital input A. They are, therefore, not isolated from each other or the PV input.

- CT input current: 0-50mA rms (sine wave, calibrated) 50/60Hz
- A burden resistor, value 10Ω , is fitted inside the controller.
- It is recommended that the current transformer is fitted with a voltage limiting device to prevent high voltage transients if the controller is unplugged. For example, two back to back zener diodes. The zener voltage should be between 3 and 10V, rated at 50mA.
- CT input resolution: 0.1A for scale up to 10A, 1A for scale 11 to 100A
- CT input accuracy: $\pm 4\%$ of reading.

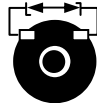

2.13 Digital Communications Optional

Digital communications uses the Modbus protocol. The interface may be ordered as RS232 or RS485 (2-wire).

☺ Digital communications is not available if Remote Setpoint is fitted

- Isolated 240Vac CATII.

2.13.1.1 RS232 Connections

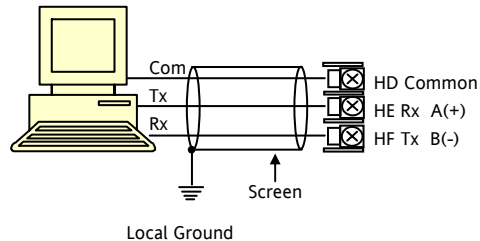

2.13.1.2 RS485 Connections

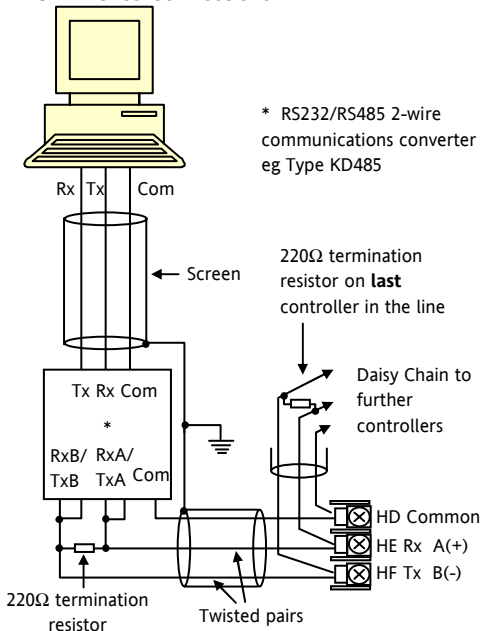

2.13.1.3 RS422 Connections (3216 only)

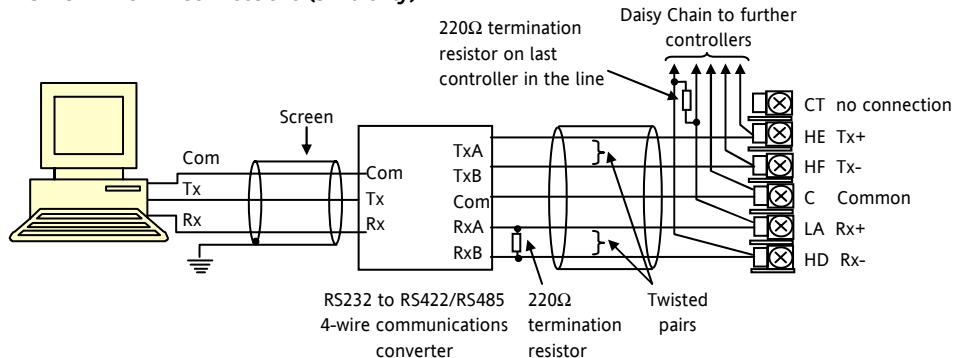

☺ If RS422 serial communications is fitted, the CT and LA digital input option is not possible since RS422 shares the same terminals as the CT and LA.

☺ The 261 or KD485 communications converter is recommended for:

- Interfacing 4-wire to 2-wire connections.
- To buffer an RS422/485 network when more than 32 instruments on the same bus are required
- To bridge 2-wire RS485 to 4-wire RS422.

2.14 Controller Power Supply

1. Before connecting the controller to the power line, make sure that the line voltage corresponds to the description on the identification label.
2. Use copper conductors only.
3. The power supply input is not fuse protected. This should be provided externally.
4. For 24V the polarity is not important.

Power Supply

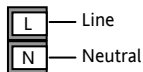

- High voltage supply: 100 to 240Vac, -15%, +10%, 50/60 Hz
- Low voltage supply: 24Vac/dc, -15%, +10%
- Recommended external fuse ratings are as follows:-
For 24 V ac/dc, fuse type: T rated 2A 250V
For 100-240Vac, fuse type: T rated 2A 250V.

2.15 Example Wiring Diagram

This example shows a heat/cool temperature controller where the heater control uses a SSR and the cooling control uses a relay.

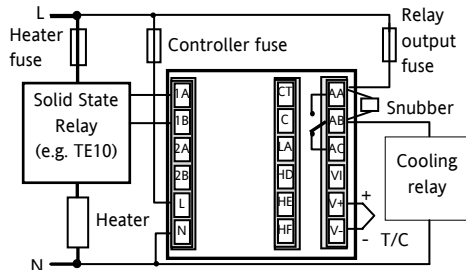

Safety requirements for permanently connected equipment state:

- A switch or circuit breaker shall be included in the building installation
- It shall be in close proximity to the equipment and within easy reach of the operator
- It shall be marked as the disconnecting device for the equipment.

Note: a single switch or circuit breaker can drive more than one instrument.

3. Safety and EMC Information

This controller is intended for industrial temperature and process control applications when it will meet the requirements of the European Directives on Safety and EMC. Use in other applications, or failure to observe the installation instructions of this handbook may impair safety or EMC. The installer must ensure the safety and EMC of any particular installation.

Safety

This controller complies with the European Low Voltage Directive 73/23/EEC, by the application of the safety standard EN 61010.

Electromagnetic compatibility

This controller conforms with the essential protection requirements of the EMC Directive 89/336/EEC, by the application of a Technical Construction File. This instrument satisfies the general requirements of the industrial environment defined in EN 61326. For more information on product compliance refer to the Technical Construction File.

GENERAL

The information contained in this manual is subject to change without notice. While every effort has been made to ensure the accuracy of the information, your supplier shall not be held liable for errors contained herein.

Unpacking and storage

The packaging should contain an instrument mounted in its sleeve, two mounting brackets for panel installation and an Installation & Operating guide. Certain ranges are supplied with an input adapter.

If on receipt, the packaging or the instrument is damaged, do not install the product but contact your supplier. If the instrument is to be stored before use, protect from humidity and dust in an ambient temperature range of -30°C to +75°C.

Service and repair

This controller has no user serviceable parts. Contact your supplier for repair.

Caution: Charged capacitors

Before removing an instrument from its sleeve, disconnect the supply and wait at least two minutes to allow capacitors to discharge. It may be convenient to partially withdraw the instrument from the sleeve, then pause before completing the removal. In any case, avoid touching the exposed electronics of an instrument when withdrawing it from the sleeve.

Failure to observe these precautions may cause damage to components of the instrument or some discomfort to the user.

Electrostatic discharge precautions

When the controller is removed from its sleeve, some of the exposed electronic components are vulnerable to damage by electrostatic discharge from someone handling the controller. To avoid this, before handling the unplugged controller discharge yourself to ground.

Cleaning

Do not use water or water based products to clean labels or they will become illegible. Isopropyl alcohol may be used to clean labels. A mild soap solution may be used to clean other exterior surfaces of the product.

3.1 Installation Safety Requirements

Safety Symbols

Various symbols may be used on the controller. They have the following meaning:



Caution, (refer to accompanying documents)



Equipment protected throughout by DOUBLE INSULATION



Helpful hints

Personnel

Installation must only be carried out by suitably qualified personnel

Enclosure of Live Parts

To prevent hands or metal tools touching parts that may be electrically live, the controller must be enclosed in an enclosure.

Caution: Live sensors

The controller is designed to operate if the temperature sensor is connected directly to an electrical heating element. However, you must ensure that service personnel do not touch connections to these inputs while they are live. With a live sensor, all cables, connectors and switches for connecting the sensor must be mains rated for use in 240Vac CATII.

Wiring

It is important to connect the controller in accordance with the wiring data given in this guide. Take particular care not to connect AC supplies to the low voltage sensor input or other low level inputs and outputs. Only use copper conductors for connections (except thermocouple inputs) and ensure that the wiring of installations comply with all local wiring regulations. For example in the UK use the latest version of the IEE wiring regulations, (BS7671). In the USA use NEC Class 1 wiring methods.

Power Isolation

The installation must include a power isolating switch or circuit breaker. This device should be in close proximity to the controller, within easy reach of the operator and marked as the disconnecting device for the instrument.

Overcurrent protection

The power supply to the system should be fused appropriately to protect the cabling to the units.

Voltage rating

The maximum continuous voltage applied between any of the following terminals must not exceed 240Vac:

- relay output to logic, dc or sensor connections;
- any connection to ground.

The controller must not be wired to a three phase supply with an unearthed star connection. Under fault conditions such a supply could rise above 240Vac with respect to ground and the product would not be safe.

Conductive pollution

Electrically conductive pollution must be excluded from the cabinet in which the controller is mounted. For example, carbon dust is a form of electrically conductive pollution. To secure a suitable atmosphere in conditions of conductive pollution, fit an air filter to the air intake of the cabinet. Where condensation is likely, for example at low temperatures, include a thermostatically controlled heater in the cabinet.

This product has been designed to conform to BSEN61010 installation category II, pollution degree 2. These are defined as follows:-

Installation Category II (CAT II)

The rated impulse voltage for equipment on nominal 230V supply is 2500V.

Pollution Degree 2

Normally only non conductive pollution occurs. Occasionally, however, a temporary conductivity caused by condensation shall be expected.

Grounding of the temperature sensor shield

In some installations it is common practice to replace the temperature sensor while the controller is still powered up. Under these conditions, as additional protection against electric shock, we recommend that the shield of the temperature sensor is grounded. Do not rely on grounding through the framework of the machine.

Over-temperature protection

When designing any control system it is essential to consider what will happen if any part of the system should fail. In temperature control applications the primary danger is that the heating will remain

constantly on. Apart from spoiling the product, this could damage any process machinery being controlled, or even cause a fire.

Reasons why the heating might remain constantly on include:

- the temperature sensor becoming detached from the process
- thermocouple wiring becoming short circuit;
- the controller failing with its heating output constantly on
- an external valve or contactor sticking in the heating condition
- the controller setpoint set too high.

Where damage or injury is possible, we recommend fitting a separate over-temperature protection unit, with an independent temperature sensor, which will isolate the heating circuit.

Please note that the alarm relays within the controller will not give protection under all failure conditions.

Installation requirements for EMC

To ensure compliance with the European EMC directive certain installation precautions are necessary as follows:

- For general guidance refer to Eurotherm Controls EMC Installation Guide, HA025464.
- When using relay outputs it may be necessary to fit a filter suitable for suppressing the emissions. The filter requirements will depend on the type of load. For typical applications we recommend Schaffner FN321 or FN612.
- If the unit is used in table top equipment which is plugged into a standard power socket, then it is likely that compliance to the commercial and light industrial emissions standard is required. In this case to meet the conducted emissions requirement, a suitable mains filter should be installed. We recommend Schaffner types FN321 and FN612.

Routing of wires

To minimise the pick-up of electrical noise, the low voltage DC connections and the sensor input wiring should be routed away from high-current power cables. Where it is impractical to do this, use shielded cables with the shield grounded at both ends. In general keep cable lengths to a minimum.

4. Switch On

A brief start up sequence consists of a self test in which all elements of the display are illuminated and the software version number is shown. What happens next depends on one of two conditions:-

1. The controller is new and has been supplied un-configured (go to section 4.1)
2. The controller has been supplied configured in accordance with the Quick Start code (go to section 4.3).

4.1 Initial Configuration

If the controller has not previously been configured it will start up showing the 'Quick Configuration' codes. This is a built in tool which enables you to configure the input type and range, the output functions and the display format.









Incorrect configuration can result in damage to the process and/or personal injury and must be carried out by a competent person authorised to do so. It is the responsibility of the person commissioning the controller to ensure the configuration is correct

The quick code consists of two 'SETS' of five characters. The upper section of the display shows the set selected, the lower section shows the five digits which make up the set.





Adjust these as follows:-

1. Press any button. The first character will change to a flashing '-'.
 or 
2. Press  or  to change the flashing character to the required code shown in the quick code tables –see next page. Note: An 'H' indicates that the option is not fitted.
3. Press  to scroll to the next character. If you need to return to the first character press . When all five characters have been configured the display will go to Set 2.

When the last digit has been entered press  again,

the display will show

Press  or  to

The controller will then automatically go to the operator level.

Input type		Range		Input/Output 1		Output 2		Output 4	
Thermocouple		Full range		X	Unconfigured		Note (1) O/P 4 Relay only		
B	Type B	C	°C	H	PID Heating (logic, relay ⁽¹⁾ , triac or 4-20mA or motor valve open VP, VC only)				
J	Type J	F	°F	C	PID Cooling (logic, relay ⁽¹⁾ , triac or 4-20mA or motor valve close VP, VC only)				
K	Type K	Centigrade		J	ON/OFF Heating (logic, triac or relay ⁽¹⁾), or PID 0-20mA heating				
L	Type L	0	0-100	K	ON/OFF Cooling (logic, triac or relay ⁽¹⁾), or PID 0-20mA cooling				
N	Type N	1	0-200	Alarm⁽²⁾: energised in alarm		Alarm⁽²⁾: de-energised in alarm			
R	Type R	2	0-400	0	High alarm	5	High alarm	Note (2) OP1 = alarm 1 OP2 = alarm 2 OP3 = alarm 3 OP4 = alarm 4	
S	Type S	3	0-500	1	Low alarm	6	Low alarm		
T	Type T	4	0-800	2	Deviation high	7	Deviation high		
C	Custom	5	0-1000	3	Deviation low	8	Deviation low		
RTD		6	0-1200	4	Deviation band	9	Deviation band		
p	Pt100	7	0-1400	DC Retransmission (not O/P4)					
Linear		8	0-1600	D	4-20mA Setpoint	N	0-20mA Setpoint		
M	0-80mV	9	0-1800	E	4-20mA Temperature	Y	0-20mA Temperature		
2	0-20mA	Fahrenheit		F	4-20mA output	Z	0-20mA output		
4	4-20mA	G	32-212	Logic input functions (Input/Output 1 only)					
		H	32-392	W	Alarm acknowledge	V	Recipe 2/1 select		
		J	32-752	M	Manual select	A	Remote UP button		
		K	32-1112	R	Timer/program run	B	Remote DOWN button		
		L	32-1472	L	Keylock	G	Timer/Prog Run/Reset		
		M	32-1832	P	Setpoint 2 select	I	Timer/Program Hold		
R	32-2912	N	32-2192	T	Timer/program Reset	Q	Standby select		
T	32-3272	P	32-2552	U	Remote SP enable				

SET 2

I W R D T

Input CT Scaling		Digital Input A		Digital Input B (3)		Output 3 (3)				Lower Display		
X	Unconfigured	X	Unconfigured	X	Unconfigured	X	Unconfigured		T	Setpoint (std)		
1	10 Amps	W	Alarm acknowledge	H	PID heating or motor valve open (4)							
2	25 Amps	M	Manual select	C	PID cooling or motor valve close (4)				P	Output		
5	50 Amps	R	Timer/Program Run	J	ON/OFF heating				R	Time remaining		
6	100 Amps	L	Keylock	K	ON/OFF cooling				E	Elapsed time		
		P	Setpoint 2 select	Alarm Outputs(2) Energised in alarm De-energised in alarm				1	Alarm setpoint			
		T	Timer/Program reset					0	High alarm	5	High alarm	A
		U	Remote SP enable	1	Low alarm	6	Low alarm	D	Dwell/Ramp Time/Target			
		V	Recipe 2/1 select	2	Dev High	7	Dev High	N	None			
		A	Remote UP button	3	Dev Low	8	Dev Low	C	Setpoint with Output meter (4)			
		B	Remote DOWN button	4	Dev Band	9	Dev Band	M	Setpoint with Ammeter (4)			
		G	Timer/Prog Run/Reset									
		I	Timer/Program Hold									
		Q	Standby select									
						DC outputs Retransmission Control						
		D	4-20 Setpoint		H	4-20mA heating						
		E	4-20 Measured Temperature		C	4-20mA cooling						
		F	4-20mA output		J	0-20mA heating						
		N	0-20 Setpoint		K	0-20mA cooling						
		Y	0-20 Measured Temperature									
		Z	0-20mA output									

Note (2)

- OP1 = alarm 1
- OP2 = alarm 2
- OP3 = alarm 3
- OP4 = alarm 4

Note (3)



Not 3216

Note (4)

VP, VC only

4.2 To Re-Enter Quick Code configuration mode

If you need to re-enter the 'Quick Configuration' mode this can always be done by powering down the controller, holding down the  button, and powering up the controller again.

You must then enter a passcode using the  or  buttons. In a new controller the passcode defaults to 4. If an incorrect passcode is entered you must repeat the whole procedure.

Note- Parameters may also be configured using a deeper level of access. This is described in the 3200 Engineering Handbook Part No. HA027986. This may be downloaded from www.eurotherm.co.uk.

4.3 Pre-Configured Controller or Subsequent Starts

The controller will briefly display the quick codes during start up and then proceed to operator level 1. You will see the display shown below. It is called the HOME disp

3208 example

The ALM beacon will show red if an alarm is present.

The OP4 beacon will be on if output 4 is active



Measured Temperature
←
Target Temperature (Setpoint)

Note:- If the Quick Codes do not appear during start up, this means that the controller has been configured in a deeper level of access, as stated opposite. The quick codes may then not be valid and are therefore not shown.

4.4 Front panel layout

Beacons:-

ALM	Alarm active (Red)
OP1	Lit when output 1 is ON (normally heating)
OP2	Lit when output 2 is ON (normally cooling)
)	
OP3	Lit when output 3 is ON
OP4	Lit when output 4 is ON (normally alarm)
SPX	Alternative setpoint in use (SP2)
REM	Remote setpoint or communications active
RUN	Timer/programmer running
RUN	(flashing) Timer/programmer in hold
MAN	Manual mode selected

Operator Buttons:-



From any display - press to return to the HOME display.



Press to select a new parameter. If held down it will continuously scroll through parameters.



Press to change or decrease a value.



Press to change or increase a value.

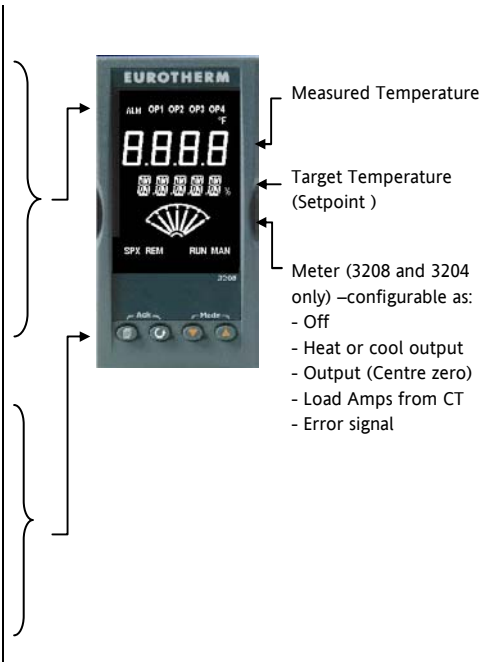

4.4.1 To Set The Target Temperature (setpoint)

In the HOME display:-



Press  to raise the setpoint

Press  to lower the setpoint

The new setpoint is entered when the button is released and is indicated by a brief flash of the display.

4.4.2 Alarm Indication

If an alarm occurs, the red ALM beacon will flash. A scrolling text message will describe the source of the alarm. Any output attached to the alarm will operate.

Press  and  (ACK) together to acknowledge the alarm



If the alarm is still present the ALM beacon will light continuously.

By default alarms are configured as non-latching, de-energised in alarm. If you require latched alarms, please refer to the engineering handbook.

4.4.3 Auto, Manual and Off Mode

The controller can be put into Auto, Manual or Off mode – see next section.



Auto mode is the normal operation where the output is adjusted automatically by the controller in response to changes in the measured temperature.

Manual mode means that the controller output power is manually set by the operator. The input sensor is still connected and reading the temperature but the control loop is ‘open’. In manual mode the MAN beacon will be lit. The power output can be increased or decreased using the  or  buttons.

 Manual mode must be used with care. The power level must not be set and left at a value that can damage the process or cause over-heating. The use of a separate ‘over-temperature’ controller is recommended.

Off mode means that the heating and cooling outputs are turned off. The alarm outputs will, however, still be active.

4.4.4 To Select Auto, Manual or OFF Mode

Press and hold  and  (Mode) together for more than 1 second.

This must be done in the HOME display.

1. 'Auto' is shown in the upper display. After 5 seconds the lower display will scroll the longer description of this parameter. ie 'LOOP MODE - AUTO MANUAL OFF'







2. Press  to select 'mAn'. Press again to select 'OFF'. This is shown in the upper display.



3. After 2 seconds the controller will return to the HOME display.





4. If **OFF** has been selected, **OFF** will be shown in the lower display and the heating and cooling outputs will be off

5. If manual mode has been selected, the **MAN** beacon will light. The upper display shows the measured temperature and the lower display the demanded output power.
6. The transfer from Auto to manual mode is 'bumpless'. This means the output will remain at the same value at transfer. Similarly when transferring from Manual to auto mode the initial output value will be the same.
7. In manual mode the Man beacon will be lit and the output power shown in the lower display. Press  or  to lower or raise the output. The output power is continuously updated when these buttons are pressed
8. To return to Auto mode, press  and  together. Then press  to select 'Auto'.

4.4.5 Operator Parameters in Level 1

Operator level 1 is designed for day to day operation of the controller and access to these parameters is not protected by a pass code.

Press  to step through the list of parameters. The mnemonic of the parameter is shown in the lower display. After five seconds a scrolling text description of the parameter appears.

The value of the parameter is shown in the upper display. Press  or  to adjust this value. If no key is pressed for 30 seconds the controller returns to the HOME display











The parameters that appear depend upon the functions configured. They are:-

Parameter Mnemonic	Scrolling text and Description	Availability
WRK.OP	WORKING OUTPUT The active output value	Read only. Shown when the controller is in AUTO or OFF mode. In a motorised valve controller (option VC or VP) this is the 'inferred' position of the valve.
WKG.SP	WORKING SETPOINT The active setpoint value.	Read only. Only shown when the controller is in MAN or OFF mode.
SP1	SETPOINT 1	Alterable
SP2	SETPOINT 2	Alterable
T.REMN	TIME REMAINING	Read only 0:00 to 99.59 hh:mm or mm:ss
DWELL	DWELL TIME Set time	Alterable. Only shown if timer (not programmer) configured.
A1.xxx	ALARM 1 SETPOINT	Read only. Only shown if the alarm is configured. Where: xxx = alarm type. HI = High alarm; LO = Low alarm d.HI = Deviation high; d.LO = Deviation low; d.HI = Deviation high
A2.xxx	ALARM 2 SETPOINT	
A3.xxx	ALARM 3 SETPOINT	
A4.xxx	ALARM 3 SETPOINT	
LD.AMP	LOAD CURRENT Load Amps	Read only. Only shown if CT is configured



5. Operator Level 2

Level 2 provides access to additional parameters. It is protected by a security code.

5.1 To Enter Level 2

1. From any display press and hold .
2. After a few seconds the display will show:-

3. Release 
(If no button is pressed for 45 seconds the display returns to the HOME display)
4. Press  or  to choose **LEU 2** (Level 2)

5. After 2 seconds the display will show:-

6. Press  or  to enter the pass code. Default = '2'

7. If an incorrect code is entered the controller reverts to Level 1.



5.2 To Return to Level 1



1. Press and hold .
2. Press  to select **LEU 1**

The controller will return to the level 1 HOME display. Note: A pass code is not required when going from a higher level to a lower level.

5.3 Level 2 Parameters

Press  to step through the list of parameters. The mnemonic of the parameter is shown in the lower display. After five seconds a scrolling text description of the parameter appears.

The value of the parameter is shown in the upper display. Press  or  to adjust this value. If no key is pressed for 30 seconds the controller returns to the HOME display

Backscroll is achieved when you are in this list by pressing  while holding down .

The following table shows a list of parameters available in Level 2.

Mnemonic	Scrolling Display and description	Range
WKG.SP	WORKING SETPOINT is the active setpoint value. It appears when the controller is in Manual mode. It may come from SP1 or SP2, or, if the controller is ramping (see SP.RAT), it is the present ramp value.	Read only value SP.HI to SP.LO
WRK.OP	WORKING OUTPUT is the output from the controller. It appears when the controller is in Auto mode. In a motorised valve controller (option VC or VP) this is the 'inferred' position of the valve For On/Off control: OFF = <1%. ON = >1%	Read only value 0 to 100% for heating 0 to -100% for cooling.
T.STAT	TIMER STATUS is the current state of the timer: Run, Hold, Reset or End It is only appears when a timer is configured.	Alterable value <i>rES</i> Reset <i>run</i> Running <i>hold</i> In hold <i>End</i> Timed out
UNITS	DISPLAY UNITS Temperature display units. The percentage units is provided for linear inputs	<i>°C</i> ° C <i>°F</i> ° F <i>°K</i> Kelvin <i>nonE</i> ° C (beacon off) <i>PERc</i> Percentage
SP.HI	SETPOINT HIGH High setpoint limit applied to SP1 and SP2.	Alterable between range limits
SP.LO	SETPOINT LOW Low setpoint limit applied to SP1 and SP2	
By default the remote setpoint is scaled between SP.HI and SP.LO. Two further parameters (REM.HI and REM.LO) are available in a deeper level of access to limit the Remote SP range if required. See Engineering Handbook HA027986 which can be downloaded from www.eurotherm.co.uk .		

Mnemonic	Scrolling Display and description	Range
SP1	SETPOINT 1 Setpoint 1 value	Alterable SP.HI to SP.LO
SP2	SETPOINT 2 Setpoint 2 value	Alterable SP.HI to SP.LO
SP.RAT	SETPOINT RATE LIMIT Rate of change of setpoint value.	Alterable: OFF to 3000 display units per minute

The following section applies to the Timer only – see also section 5.4

TM.CFG	TIMER CONFIGURATION Configures the timer type:- Dwell, Delay, Soft Start or none. The timer type can only be changed when the timer is reset. The Programmer option only appears if the programmer has been ordered.	<i>nonE</i>	None
		<i>dwEl1</i>	Dwell
		<i>dELY</i>	Delayed switch on
		<i>SFSL</i>	Soft start
		<i>PrOG</i>	Programmer
TM.RES	TIMER RESOLUTION Selects the resolution of the timer. This can only be changed when the timer is reset.	<i>Hour</i>	Hours
		<i>mi n</i>	Minutes
THRES	TIMER START THRESHOLD The timer starts timing when the temperature is within this threshold of the setpoint. This provides a guaranteed soak temperature. The threshold can be set to OFF in which case it is ignored and the timing starts immediately. If a setpoint ramping is set, then the ramp completes before the timer starts.	OFF or 1 to 3000 units/minute	

Mnemonic	Scrolling Display and description	Range
END.T	TIMER END TYPE This determines the behaviour of the timer when it has timed out. This value can be changed while the timer is running.	<i>OFF</i> Control OP goes to zero <i>dwE11</i> Control continues at SP1 <i>SP2</i> Go to SP2 <i>rES</i> Reset programmer
SS.PWR	SOFT START POWER LIMIT This parameter only appears if the timer configuration is set to <i>SFSE</i> (Softstart). It sets a power limit which is applied until the measured temperature reaches a threshold value (SS.SP) or the set time (DWELL) has elapsed. The timer starts automatically on power up.	-100 to 100%
SS.SP	SOFT START SETPOINT This parameter only appears if the timer configuration is set to <i>SFSE</i> (Softstart). It sets the threshold value below which the power is limited	Between SP.HI and SP.LO
DWELL	SET TIME DURATION – Sets the dwell timing period. It can be adjusted while the timer is running.	0:00 to 99.59 hh:mm: or mm:ss
T.REMN	TIME REMAINING Timer time remaining. This value can be increased or decreased while the timer is running	0:00 to 99.59 hh:mm: or mm:ss

Mnemonic	Scrolling Display and description	Range
The following parameters are available when the timer is configured as a programmer – see also section 5.8		
SERVO	SERVO MODE. Sets the starting point for the ramp/dwell programmer and the action on recovery from power failure. See also section 5.8.1	<i>SP</i> Setpoint <i>PU</i> Temperature <i>SP_rb</i> Ramp back to SP <i>PU_rb</i> Ramp back to PV
TSP.1	TARGET SETPOINT 1. Sets the value of target setpoint 1	
RMP.1	RAMP RATE 1. Sets ramp rate 1	OFF, 0:01 to 3000 units per min or hour as set by TM.RES
DWEL.1	DWELL 1. Sets dwell time 1	OFF, 0:01 to 99:59 hh:mm or mm:ss as set by TM.RES
The above three parameters are repeated for the next three program segments, i. e. TSP.2 (3 & 4), RMP.2 (3 & 4), DWEL.2 (3 & 4)		
This section applies to Alarms only If an alarm is not configured the parameters do not appear		
A1xxx	ALARM 1 (2, 3 or 4) SETPOINT Sets the threshold value at which an	SP.HI to SP.LO
A2.xxx	alarm occurs. Up to four alarms are available.	
A3.xxx	The last three characters in the mnemonic specify the alarm type:	
A4.xxx	HI = High alarm, LO = Low alarm DHI = Deviation high, DLO = Deviation low BND = Deviation band alarm	

Mnemonic	Scrolling Display and description	Range
The following parameter is present if a motorised valve controller has been ordered		
MTR.T	MOTOR TRAVEL TIME. Set this value to the time that it takes for the motor to travel from its fully closed to its fully open position. Note: In motorised valve control only the PB and TI parameters are active – see below. The TD parameter has no effect on the control.	0.0 to 999.9 seconds
This section applies to control the parameters. A further description of these parameters is given in section 11 of the Engineering Handbook part no. HA028651.		
A.TUNE	AUTOTUNE Automatically sets the control parameters to match the process characteristics.	OFF Disable On Enable
PB	PROPORTIONAL BAND Sets an output which is proportional to the amplitude of the error signal. Units may be in % or display units.	1 to 9999 display units Default 20
TI	INTEGRAL TIME Removes steady state control offsets by ramping the output up or down in proportion to the amplitude and duration of the error signal.	OFF to 9999 seconds Default 360
TD	DERIVATIVE TIME Determines how strongly the controller will react to the rate of change temperature. It is used to prevent overshoot and undershoot, and to restore the PV rapidly if there is a sudden change in demand.	OFF to 9999 seconds Default 60 for PID control Default 0 for valve position control

Mnemonic	Scrolling Display and description	Range
MR	MANUAL RESET applies to a PD only controller i.e. the integral term is turned off. Set this to a value of power output (from +100% heat, to -100% cool which removes any steady state error between SP and PV.	-100 to 100% Default 0
R2G	RELATIVE COOL GAIN adjusts the cooling proportional band relative to the heating proportional band. Particularly necessary if the rate of heating and rate of cooling are very different. (Heat/Cool only)	0.1 to 10.0 Default 1.0
HYST.H	HEATING HYSTERESIS Sets the difference in temperature units between heating turning off and turning on when ON/OFF control is used. Only appears if channel 1(heating) control action is On/Off.	0.1 to 200.0 display units Default 1.0
HYST.C	COOLING HYSTERESIS Sets the difference in temperature units between cooling turning off and turning on when ON/OFF control is used. Only appears if channel 2(cooling) control action is On/Off.	0.1 to 200.0 display units Default 1.0
D.BAND	CHANNEL 2 DEADBAND Sets a zone between heating and cooling outputs when neither output is on. Off = no deadband. 100 = heating and cooling off. Only appears if On/Off control configured.	<i>OFF</i> or 0.1 to 100.0% of the cooling proportional band
OP.HI	OUTPUT HIGH Sets the maximum heating power applied to the process or the minimum cooling output.	+100% to OP.LO

Mnemonic	Scrolling Display and description	Range
1. (2, 3 or 4) PLS.	<p>OUTPUT 1 (2, 3 or 4) MINIMUM PULSE TIME Sets the minimum on and off time for the control output.</p> <p> Ensure this parameter is set to a value that is suitable for the output switching device in use. For example, if a logic output is used to switch a small relay, set the value to 5.0 seconds or greater to prevent damage to the device due to rapid switching.</p>	<p>Relay outputs 0.1 to 150.0 seconds – default 5.0.</p> <p>Logic outputs Auto to 150.0 -Default Auto = 55ms</p>

<p>This section applies to current transformer input. If the CT option is not configured the parameters do not appear</p>		
LD.AMP	LOAD CURRENT Is the measured load current when the output is on	CT Range
LK.AMP	LEAK CURRENT Is the measured leakage current when output is off.	CT Range
LD.ALM	LOAD CURRENT THRESHOLD Sets a low alarm on the load current measured by the CT. Used to detect partial load failure.	CT Range
LK.ALM	LEAK CURRENT THRESHOLD Sets a high alarm on the leakage current measured by the CT.	CT Range
HC.ALM	OVERCURRENT THRESHOLD Sets a high alarm on the load current measured by the CT	CT Range
ADDR	ADDRESS - communications address of the controller. 1 to 254	1 to 254

Mnemonic	Scrolling Display and description	Range
HOME	HOME DISPLAY Defines the parameter which appears in the lower section of the HOME display	<i>Std</i> Standard
		<i>OP</i> Output power
		<i>Tr</i> Time remaining
		<i>ELAP</i> Time elapsed
		<i>AL</i> First alarm setpoint
		<i>CL</i> Load current
		<i>CLR</i> Clear (blank)
		<i>Emr</i> Combined SP and time display
ID	CUSTOMER ID Sets a number from 0 to 9999 used as a custom defined identification number for the controller	0 to 9999
REC.NO	CURRENT RECIPE NUMBER Displays the current recipe number. If this number is changed, the parameter values stored under the selected recipe number will be loaded. See the engineering manual for more information about recipes.	<i>nonE</i> or 1 to 5 or <i>FA, L</i> if no recipe stored
STORE	RECIPE TO SAVE Saves the current parameter values into a selected recipe number. Up to 5 recipes can be saved.	<i>nonE</i> or 1 to 5 <i>donE</i> when stored

☺ Press  at any time to return immediately to the HOME screen at the top of the list.

☺ Hold  down to continuously scroll through the above list

5.4 Timer Operation

An internal timer can be configured to operate in one of four different modes. The mode is configured in Level 2 by the 'TM.CFG' (timer configuration) parameter. Each Timing Mode is described in the pages that follow.

Operation	Action	Indication
To Run the timer	Press and quickly release ▼ + ▲	Beacon -- RUN = On Scrolling text display:- TIMER RUNNING
To Hold the timer	Press and quickly release ▼ + ▲	Beacon -- RUN = Flashing Scrolling text display:- TIMER HOLD
To Reset the timer	Press and hold ▼ + ▲ for more than 1 second	Beacon -- RUN = Off If the timer is a Dwell Type and configured to turn power off at the end of the timing period OFF will be displayed
	Timer has timed out (END state)	Beacon -- RUN = Off SPX = On if End Type = SP2 Scrolling display:- TIMER END. Note:- The timer can be re-run from the end state without the need to reset it.

The timer can also be RUN, HELD or RESET by the parameter 'T.STAT' (Timer status). It can also be controlled via digital inputs (if configured).

5.5 Dwell Timer

A dwell timer ('**TLCFG**' = '**dwEll**') is used to control a process at a fixed temperature for a defined period.

In reset the controller behaviour depends on the configuration of the END state parameter. See opposite.

In run the heating or cooling will come on. Timing starts when the temperature is within the threshold '**THRES**' of the setpoint. If the threshold is set to OFF the timing starts immediately.

If setpoint ramping is enabled, then the ramp completes before the timer starts.

In the END state the behaviour is determined by the parameter '**END.T**' (End type):

OFF: The heating and cooling is turned OFF (resets to Off)

Dwell: Controls at setpoint1 (resets to Setpoint 1)
SP2 Controls at setpoint 2 (resets to Setpoint 1)

Note: The dwell period can be reduced or increased while the timer is running.

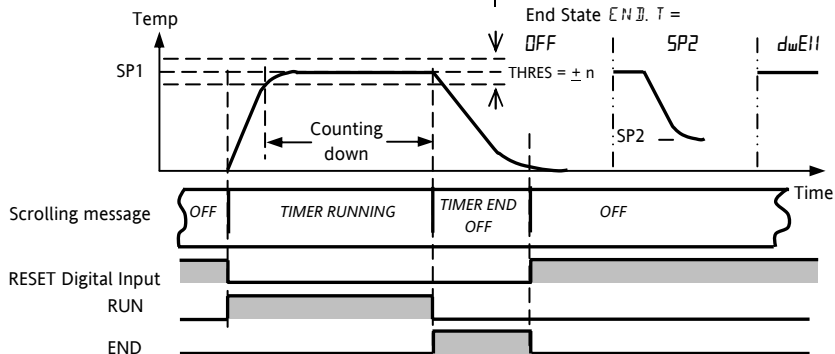

5.6 Delayed Timer

'TLCFG' = 'DELY'. The timer is used to switch on the output power after a set time. The timer starts immediately on power-up, or when run. The controller remains in standby with heating and

cooling off, until the time has elapsed. After the time has elapsed, the instrument controls at the target setpoint.

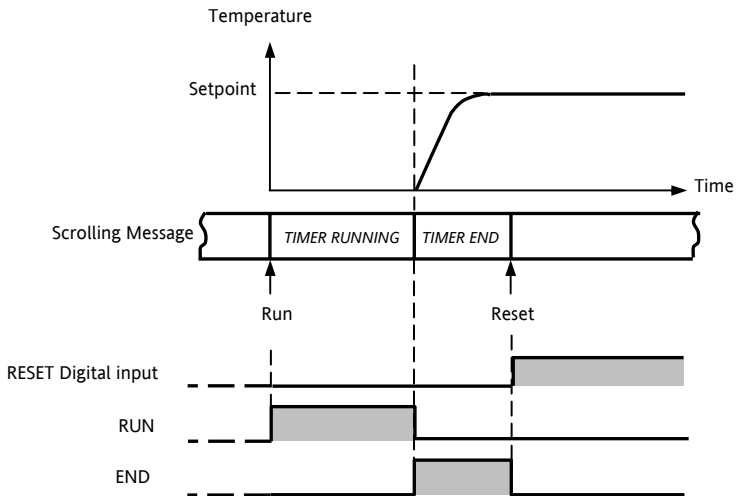

5.7 Soft Start Timer

'**TI.CFG**' = '**SS.St**'. A Soft Start timer starts automatically on power up. It applies a power limit ('**SS.PWR**') until the temperature reaches a threshold value ('**SS.SP**') or the timer times-out

after the dwell period ('**Dwell**'). It is typically use to dry-out heaters in Hot Runner control systems

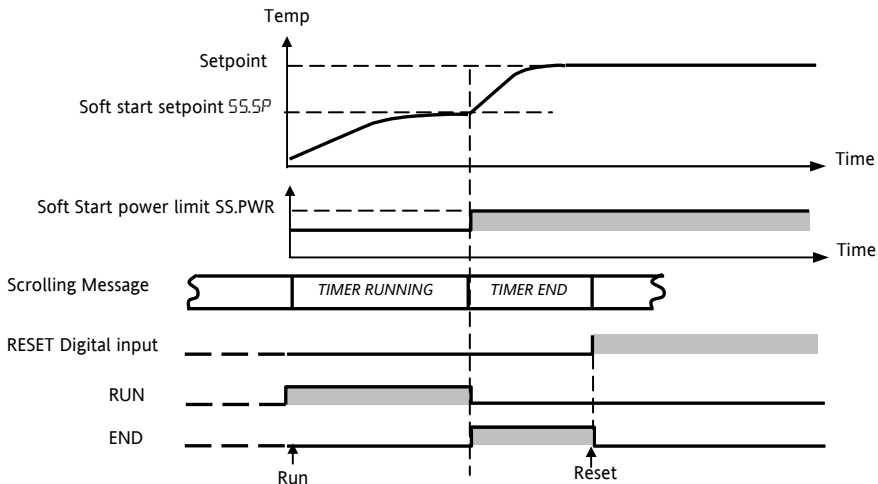

5.8 Programmer

'TLCFG' = 'ProG'. Function code CP contains a four segment programmer where each segment consists of a controlled ramp rate to a target setpoint below.

followed by a dwell at that setpoint. These values are set by the user. The program profile is shown in the diagram

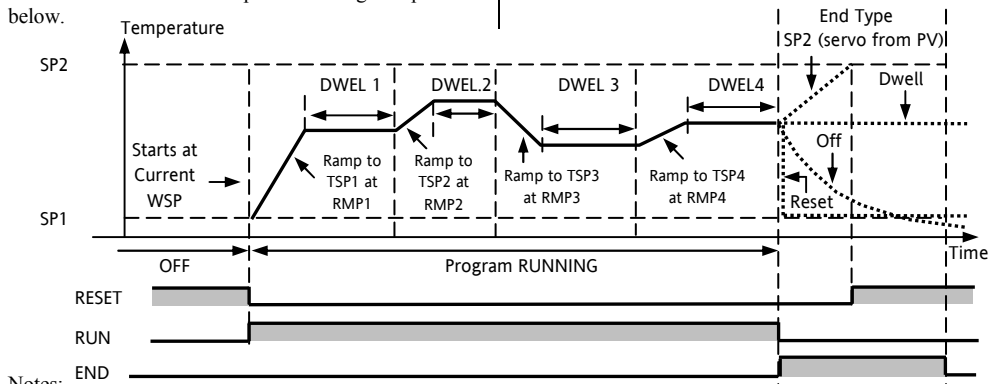

Notes:-

1. When a step change is required, set ramp rate to 'OFF'.
2. Where ramp/dwell pairs are not required, set the ramp rate to 'OFF' and the TSP the same as the preceding segment
3. TIMER END - when the end type is SP2, Timer END does not occur until the ramp is complete or SP2 is achieved. It is more usual to use a DWELL (default) or RESET end type
4. A single program event output is also available. To use this refer to the engineering manual.

5.8.1 Programmer Servo Mode and Power Cycling

The way in which the program starts when 'Run' is selected or after the power is turned off and on again, is determined by the SERVO MODE parameter, as follows:-





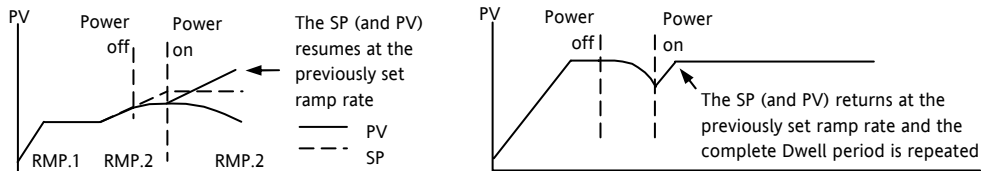

SP	The program will start from the current setpoint value. On recovery from power failure, the program will reset. It will require to be run again manually. The working setpoint will revert to SP1 or SP2 (depending on which was selected) and the whole program is repeated.
PV	The program will start from the measured temperature . On recovery from power failure, the program will reset. It will require to be run again manually, but it will start at the value of the PV at the point when the programmer is run again.
SP.rb	The program will start from the current setpoint value. On recovery from power failure, the program will automatically run at the last ramp rate from the original setpoint value (SP1 or SP2) , see the sketches below.
PV.rb	The program will start from the measured temperature . On recovery from power failure, the program will automatically run at the last ramp rate from the current measured temperature , see the sketches below.

The behavior of the programmer following a power failure is shown graphically below for SERVO = SP.rb and PV.rb:-



5.8.2 To Operate the Programmer

















Operation of the programmer is the same as the timer.

















Operation	Action	Indication
To Run a program	Press and quickly release  + 	Beacon -- RUN = On Scrolling display - TIMER RUNNING
To Hold a program	Press and quickly release  + 	Beacon -- RUN = Flashing Scrolling display - TIMER HOLD
To Reset a program	Press and hold  +  for more than 1 second	Beacon -- RUN = Off If End Type = Off then OFF will be displayed at the end of the program
	Program ended	Beacon -- RUN = Off SPX = On if End Type = SP2 Scrolling display - TIMER END
Repeat the above to Run the programmer again (Note: it is not essential to reset it after the End state is reached)		

Programs can also be operated from the 'T.STAT' parameter found in the level 2 parameter list.

5.8.3 To Configure the Programmer

Select Access Level 2 – see section 5.1.

Operation	Action	Indication	Notes
Configure the Timer as a Programmer	Press  to select 'TM.CFG' Press  or  to 'Prog'		
Set the Resolution	Press  to select 'TM.RES' Press  or  to 'Hour' or 'min'		In this example Dwell is set in hours and Rate in units/hour
Set the Threshold	Press  to select 'THRES' Press  or  to adjust		In this example the dwell periods will not start until the PV is within 5 units of the setpoint
Set the action when the programmer times out	Press  to select 'END.T' Press  or  to 'OFF' or 'SP2' or 'dwell'		In this example the controller will continue to control indefinitely at the last setpoint. OFF will turn the output power off and SP2 will control at setpoint 2

Set the Servo Mode	Press  to select 'SERVO' Press  or  to 'PU', 'SP', 'SPrb', or 'PURb'		In this example the program will start from the current value of the process variable. See also section 5.8.1
Set the first Target Setpoint	Press  to select 'TSP.1' Press  or  to adjust		In this example the setpoint will ramp from the current value of the PV to the first target - 100
Set the first Ramp Rate	Press  to select 'RMP.1' Press  or  to adjust		In this example the setpoint will ramp to 100 at 8.0 units per hour
Set the first Dwell	Press  to select 'DWEL.1' Press  or  to adjust		In this example the setpoint will remain at the start value for 2 hours 11 minutes
Repeat the above three steps for all segments			

Notes:-

- It is possible to set, in a deeper level of access, Event Outputs and Programmer Cycles.
- 'Event Outputs' is available in software version 2 and above. A digital event may be configured to operate in any segment of the program. This event may be configured to operate a digital output.
- 'Programmer Cycles' is available from software versions 2.09 (PID controllers) and 2.29 (Valve Position controllers). This allows the programmer to repeat the set program up to 100 times.
- An explanation of how to set up these parameters is given in the Engineering Handbook part number HA028651 which may be downloaded from www.eurotherm.co.uk.

 This indicator meets the European directives on safety and EMC